

ENG

BOFFIN II 175 LIGHT

Instruction Manual

175
projects

55
components

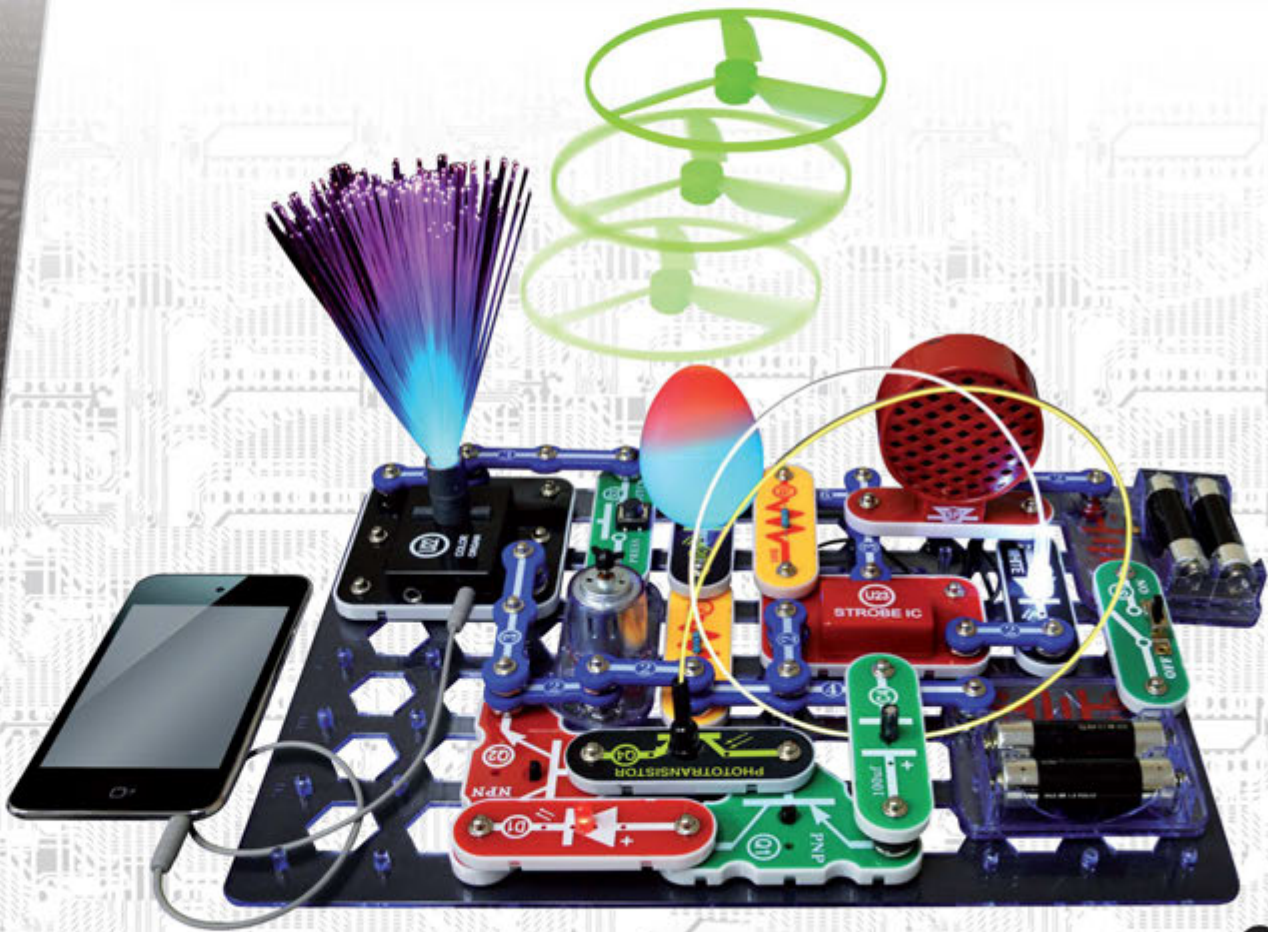



8+
age

Table of Contents

| | | | |
|-------------------------------|--------|--------------------------------------|---------|
| Basic Troubleshooting | 1 | DO's and DON'Ts of Building Circuits | 13 |
| Parts List | 2, 3 | Advanced Troubleshooting | 14, 15 |
| How to Use Boffin | 4, 5 | Project Listings | 16, 17 |
| About Your Boffin LIGHT Parts | 6 - 8 | Projects 1 - 183 | 18 - 81 |
| Introduction to Electricity | 9 | Other Boffin Projects | 82 |
| Light in Our World | 10 -12 | | |

Apple Inc. is not affiliated with nor endorses this product. iPod® is a registered trademark of Apple Inc.

 **WARNING FOR ALL PROJECTS WITH A  SYMBOL** - Moving parts. Do not touch the motor or fan during operation. Do not lean over the motor. Do not launch the fan at people, animals, or objects. Eye protection is recommended. 

 **WARNING: SHOCK HAZARD** - Never connect Boffin to the electrical outlets in your home in any way!

 **WARNING: CHOKING HAZARD** - Small parts. Not for children under 3 years.

Conforms to
ASTM
F963-96A

Basic Troubleshooting

1. Most circuit problems are due to incorrect assembly, always double-check that your circuit exactly matches the drawing for it.
2. Be sure that parts with positive/negative markings are positioned as per the drawing.
3. Be sure that all connections are securely snapped.
4. Try replacing the batteries.
5. If the motor spins but does not balance the fan, check the black plastic piece with three prongs on the motor shaft, and replace it if it is damaged (this kit includes a spare). To replace, pry the broken one off the motor shaft using a screwdriver, then push the new one on.
6. If a fiber optics circuit isn't working, make sure the clear & black cable holders are pushed all the way onto the LED/phototransistor, and the fiber optic cable is pushed into the holders as far as it will go. The cable should be standing straight up in th holders.

ConQuest entertainment is not responsible for parts damaged due to incorrect wiring.

Note: If you suspect you have damaged parts, you can follow the Advanced Troubleshooting procedure on page 15 to determine which ones need replacing.

WARNING: Always check your wiring before turning on a circuit. Never leave a circuit unattended while the batteries are installed. Never connect additional batteries or any other power sources to your circuits. Discard any cracked or broken parts.

Adult Supervision: Because children's abilities vary so much, even with age groups, adults should exercise discretion as to which experiments are suitable and safe (the instructions should enable supervising adults to establish the experiment's suitability for the child). Make sure your child reads and follows all of the relevant

instructions and safety procedures, and keeps them at hand for reference.

This product is intended for use by adults and children who have attained sufficient maturity to read and follow directions and warnings.

Never modify your parts, as doing so may disable important safety features in them, and could put your child at risk of injury.











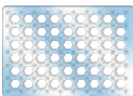











CAUTION: Persons who are extremely sensitive to flashing lights and rapidly changing colors or patterns should exercise caution when playing with this toy.

Batteries:

- Use only 1.5V AA type, alkaline batteries (not included).
- Insert batteries with correct polarity.
- Non-rechargeable batteries should not be recharged. Rechargeable batteries should only be charged under adult supervision, and should not be recharged while in the product.
- Do not mix old and new batteries.
- Do not connect batteries or battery holders in parallel.
- Do not mix alkaline, standard (carbon-zinc), or rechargeable (nickel-cadmium) batteries.
- Remove batteries when they are used up.
- Do not short circuit the battery terminals.
- Never throw batteries in a fire or attempt to open its outer casing.
- Batteries are harmful if swallowed, so keep away from small children.























Parts List (Colors and styles may vary) Symbols and Numbers (page 1)

Important: If any parts are missing or damaged, **DO NOT RETURN TO RETAILER.** Call toll-free 284 000 111 or e-mail us at: info@cqe.cz. Customer Service • ConQuest entertainment a.s., Kolbenova 961, 198 00 Praha 9, www.boffin.cz, www.toy.cz.

| Qty. | ID | Name | Symbol | Part # | Qty. | ID | Name | Symbol | Part # |
|------|------|---|---|--------|------|------|------------------------------------|---|---------|
| ☐ 1 | | Base Grid (11.0" x 7.7") |  | 6SCBG | ☐ 1 | (D6) | White Light Emitting Diode (LED) |  | 6SCD6 |
| ☐ 3 | (1) | 1-Snap Wire |  | 6SC01 | ☐ 1 | (D8) | Color Light Emitting Diode (LED) |  | 6SCD8 |
| ☐ 6 | (2) | 2-Snap Wire |  | 6SC02 | ☐ 1 | | Jumper Wire (black) |  | 6SCJ1 |
| ☐ 3 | (3) | 3-Snap Wire |  | 6SC03 | ☐ 1 | | Jumper Wire (red) |  | 6SCJ2 |
| ☐ 1 | (4) | 4-Snap Wire |  | 6SC04 | ☐ 1 | (M1) | Motor |  | 6SCM1 |
| ☐ 1 | (5) | 5-Snap Wire |  | 6SC05 | ☐ 1 | | Spare Motor Top |  | 6SCM1T |
| ☐ 1 | (6) | 6-Snap Wire |  | 6SC06 | ☐ 1 | | Glow Fan Blade |  | 6SCM1FG |
| ☐ 2 | (B1) | Battery Holder - uses two (2) 1.5V type "AA" (not Included) |  | 6SCB1 | ☐ 1 | | Disc Holder |  | 6SCM1DH |
| ☐ 1 | (C2) | 0.1μF Capacitor |  | 6SCC2 | ☐ 1 | | Set of Disc Cutouts (6 pcs. / set) |  | 6SCM1DS |
| ☐ 1 | (C4) | 100μF Capacitor |  | 6SCC4 | ☐ 1 | (Q1) | PNP Transistor |  | 6SCQ1 |
| ☐ 1 | (D1) | Red Light Emitting Diode (LED) |  | 6SCD1 | ☐ 1 | (Q2) | NPN Transistor |  | 6SCQ2 |

Parts List (Colors and styles may vary) Symbols and Numbers (page 2)

Important: If any parts are missing or damaged, **DO NOT RETURN TO RETAILER.** Call toll-free 284 000 111 or e-mail us at: info@cqe.cz. Customer Service • ConQuest entertainment a.s., Kolbenova 961, 198 00 Praha 9, www.boffin.cz, www.toy.cz.

| Qty. | ID | Name | Symbol | Part # | Qty. | ID | Name | Symbol | Part # |
|------|-----|---------------------|---|---------|------|-----|--------------------------------------|---|----------|
| ☐ 1 | Q4 | Phototransistor |  | 6SCQ4 | ☐ 1 | U23 | Strobe IC |  | 6SCU23 |
| ☐ 1 | R1 | 100Ω Resistor |  | 6SCR1 | ☐ 1 | U24 | Infrared Receiver |  | 6SCU24 |
| ☐ 1 | R3 | 5.1kΩ Resistor |  | 6SCR3 | ☐ 1 | | Fiber Optic Cable |  | 6SCFC |
| ☐ 1 | R5 | 100kΩ Resistor |  | 6SCR5 | ☐ 1 | | Fiber Optic Cable Holder, clear |  | 6SCFCHC |
| ☐ 1 | RV | Adjustable Resistor |  | 6SCRV | ☐ 1 | | Fiber Optic Cable Holder, black |  | 6SCFCHB |
| ☐ 1 | S1 | Slide Switch |  | 6SCS1 | ☐ 1 | | Fiber Optic Tree |  | 6SCFT |
| ☐ 1 | S2 | Press Switch |  | 6SCS2 | ☐ 1 | | Mounting Base (for fiber optic tree) |  | 6SCFMB |
| ☐ 1 | SP | Speaker |  | 6SCSP | ☐ 1 | | Tower LED Attachment |  | 6SCTOWER |
| ☐ 1 | X1 | Microphone |  | 6SCX1 | ☐ 1 | | Egg LED Attachment |  | 6SCEGG |
| ☐ 1 | U22 | Color Organ |  | 6SCU22 | ☐ 1 | | Prismatic Film |  | 6SCFILM |
| ☐ 1 | | Stereo Cable |  | 9TLSCST | ☐ 1 | | Red/Green/Blue Filters Set |  | 6SCFRGB |

How to Use Boffin

Boffin uses building blocks with snaps to build the different electrical and electronic circuits in the projects. Each block has a function: there are switch blocks, light blocks, battery blocks, different length wire blocks, etc. These blocks are different colors and have numbers on them so that you can easily identify them. The blocks you will be using are shown as color symbols with level numbers next to them, allowing you to easily snap them together to form a circuit.

For Example:

This is the switch block which is green and has the marking **S2** on it. The part symbols in this booklet may not exactly match the appearance of the actual parts, but will clearly identify them.



This is a wire block which is blue and comes in different wire lengths.

This one has the number **2**, **3**, **4**, **5**, or **6** on it depending on the length of the wire connection required.



There is also a 1-snap wire that is used as a spacer or for interconnection between different layers.



You need a power source to build each circuit. This is labeled **B1** and requires two (2) 1.5V "AA" batteries (not included).



A large clear plastic base grid is included with this kit to help keep the circuit blocks properly spaced. You will see evenly spaced posts that the different blocks snap into. The base has rows labeled A-G and columns labeled 1-10.

Next to each part in every circuit drawing is a small number in black. This tells you which level the component is placed at. Place all parts on level 1 first, then all of the parts on level 2, then all of the parts on level 3, etc.

Some circuits use the jumper wires to make unusual connections. Just clip them to the metal snaps or as indicated.



Usually when the motor **M1** is used, the glow fan will usually be placed on it. On top of the motor shaft is a black plastic piece (the motor top) with three little tabs. Lay the fan on the black piece so the slots in its bottom "fall into place" around the three tabs in the motor top. If not placed properly, the fan will fall off when the motor starts to spin.



This set contains 6 pre-punched cardboard discs. These will be used with a strobe light in project 46 and others. The discs may be supplied as a single sheet; just punch them out.



To remove a disc from the holder, use your fingernail, or use a pencil to push it up from beneath one of the tabs.



How to Use Boffin

This set contains three LED attachments, which can be mounted on the LED modules (D1, D6, D8, and on U22) to enhance their light effects. The egg and tower attachments are mounted directly on the LEDs, but the fiber optic tree must be mounted using the mounting base, as shown. This is described in the projects.



Egg



Egg LED attachment mounted to D6



Light Tower LED attachment mounted to D1



Fiber Optic Tree LED attachment mounted to D8



Fiber Optic Tree



Light Tower



Fiber Optic Tree LED attachment mounted to U22

In some projects, the fiber optic cable will be mounted on the LEDs (D1, D6, D8, and on U22) or the phototransistor (Q4). This is done by placing the clear and black cable holders onto the LED/phototransistor, then inserting the fiber optic cable all the way into the holder. For best performance the cable should stand straight up in the holders, without bending them. This is described in the projects.



Black cable holder mounted to Q4

Clear cable holder mounted to D1



Correct

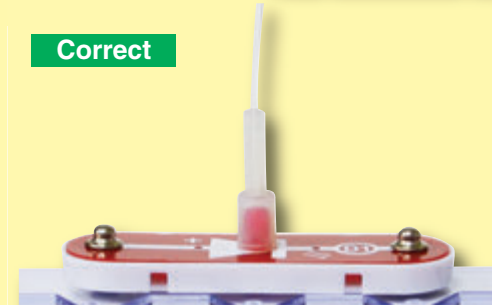

Incorrect

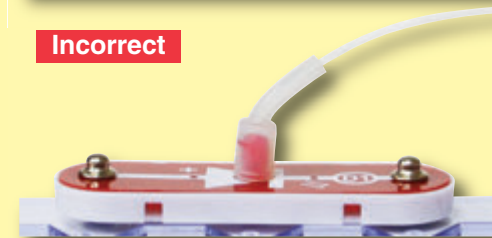

Note: While building the projects, be careful not to accidentally make a direct connection across the battery holder (a "short circuit"), as this may damage and/or quickly drain the batteries.

About Your Boffin LIGHT Parts

(Part designs are subject to change without notice).

BASE GRID

The **base grid** is a platform for mounting parts and wires. It functions like the printed circuit boards used in most electronic products, or like how the walls are used for mounting the electrical wiring in your home.

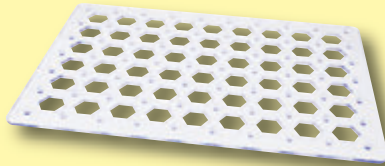

SNAP WIRES & JUMPER WIRES

The blue **snap wires** are wires used to connect components. They are used to transport electricity and do not affect circuit performance. They come in different lengths to allow orderly arrangement of connections on the base grid.

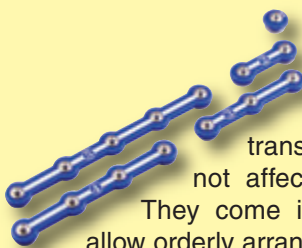

The red and black **jumper wires** make flexible connections for times when using the snap wires would be difficult. They also are used to make connections off the base grid.



Wires transport electricity just like pipes are used to transport water. The colorful plastic coating protects them and prevents electricity from getting in or out.

BATTERY HOLDER

The **batteries (B1)** produce an electrical **voltage** using a chemical reaction. This “voltage” can be thought of as electrical pressure, pushing electricity through a circuit just like a pump pushes water through pipes. This voltage is much lower and much safer than that used in your house wiring. Using more batteries increases the “pressure”, therefore, more electricity flows.

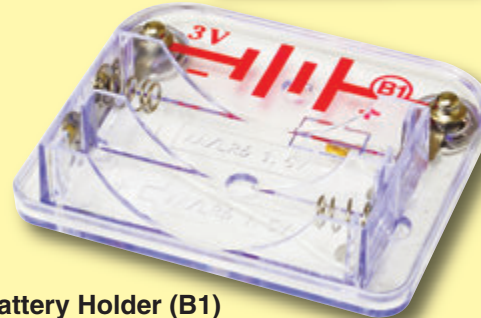

Battery Holder (B1)

MOTOR

The **motor (M1)** converts electricity into mechanical motion. An electric current in the motor will turn the shaft and the motor blades, and the fan blade if it is on the motor.



Motor (M1)

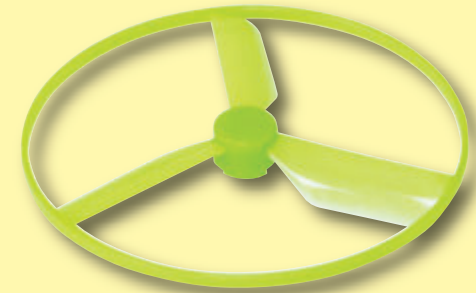

Glow-in-the-dark Fan

How does electricity turn the shaft in the motor? The answer is magnetism. Electricity is closely related to magnetism, and an electric current flowing in a wire has a magnetic field similar to that of a very, very tiny magnet. Inside the motor is a coil of wire with many loops wrapped around metal plates. This is called an electromagnet. If a large electric current flows through the loops, it will turn ordinary metal into a magnet. The motor shell also has a magnet on it. When electricity flows through the electromagnet, it repels from the magnet on the motor shell and the shaft spins. If the fan is on the motor shaft, then its blades will create airflow.

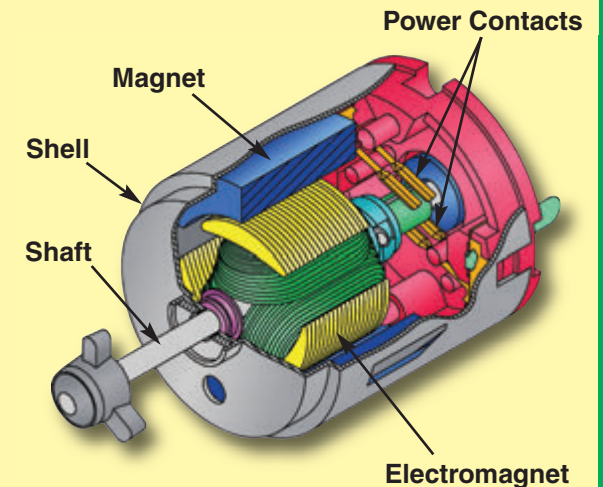

About Your Boffin LIGHT Parts

RESISTORS

Resistors “resist” the flow of electricity and are used to control or limit the current in a circuit. Boffin LIGHT includes **100Ω (R1), 5.1kΩ (R3), and 100kΩ (R5) resistors** (“k” symbolizes 1,000, so R5 is really 100,000Ω). Materials like metal have very low resistance (<1Ω), while materials like paper, plastic, and air have near-infinite resistance. Increasing circuit resistance reduces the flow of electricity.



Resistors (R1, R3, & R5)

The **adjustable resistor (RV)** is a 50kΩ resistor but with a center tap that can be adjusted between 200Ω and 50kΩ.



Adjustable Resistor (RV)

SLIDE & PRESS SWITCHES

The **slide & press switches (S1 & S2)** connect (pressed or “ON”) or disconnect (not pressed or “OFF”) the wires in a circuit. When ON they have no effect on circuit performance. Switches turn on electricity just like a faucet turns on water from a pipe.

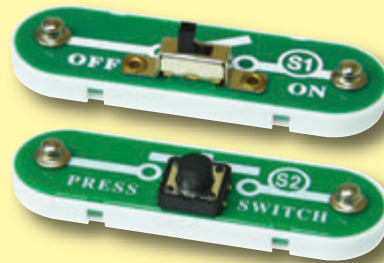

Slide & Press Switches (S1 & S2)

SPEAKER

The **speaker (SP)** converts electricity into sound by making mechanical vibrations. These vibrations create variations in air pressure, which travel across the room. You “hear” sound when your ears feel these air pressure variations.



Speaker (SP)

MICROPHONE

The **microphone (X1)** is actually a resistor that changes in value when changes in air pressure (sounds) apply pressure to its surface. Its resistance typically varies between 1kΩ and 10kΩ.

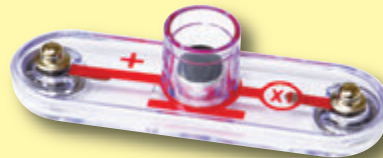

Microphone (X1)

RED & GREEN LEDs

The **red, white, and color LED's (D1, D6, & D8)** are light emitting diodes, and may be thought of as a special one-way light bulbs. In the “forward” direction, (indicated by the “arrow” in the symbol) electricity flows if the voltage exceeds a turn-on threshold (about 1.5V for red, about 3.0V for white, and in between for other colors); brightness then increases. The color LED contains red, green, and blue LEDs, with a micro-circuit controlling them. A high current will burn out an LED, so the current must be limited by other components in the circuit. LED's block electricity in the “reverse” direction.



LED's (D1, D6, & D8)

CAPACITOR

The **0.1μF and 100μF capacitors (C2 & C4)** can store electrical pressure (voltage) for periods of time. This storage ability allows them to block stable voltage signals and pass changing ones. Capacitors are used for filtering and delay circuits.



Capacitors (C2 & C4)

About Your Boffin LIGHT Parts

TRANSISTORS

The **PNP & NPN transistors (Q1 & Q2)** are components that use a small electric current to control a large current, and are used in switching, amplifier, and buffering applications. They are easy to miniaturize, and are the main building blocks of integrated circuits including the microprocessor and memory circuits in computers.



PNP & NPN Transistors (Q1 & Q2)

The **phototransistor (Q4)** is a transistor that uses light to control electric current.



Phototransistor (Q4)

ELECTRONIC MODULES

The **Infrared module (U24)** is a miniaturized infrared receiver circuit for remote control.



Infrared module (U24)

The **color organ (U22)** contains resistors, capacitors, transistors, a tri-color LED, and integrated circuits. The LED in it can change colors by direct control, or in synch with an audio input signal. A schematic for it is available at www.boffin.cz.

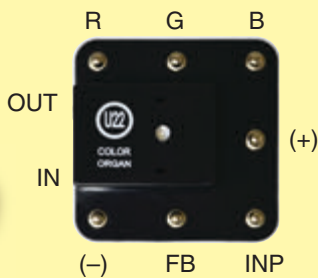

Connections:

- R - red color control
- G - green color control
- B - blue color control
- (+) - power from batteries
- INP - circuit input
- FB - feedback connection
- (-) - power return to batteries
- IN - audio input jack
- OUT - audio output jack

See projects 5, 6, 33, and 34 for examples of proper connections.

The **strobe IC (U23)** contains resistors, capacitors, and transistors that are needed to make a strobe light circuit. A schematic for it is available at www.boffin.cz.

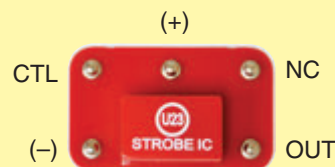

Connections:

- (+) - power from batteries
- (-) - power return to batteries
- OUT - output connection
- CTL - strobe speed control
- NC - not used

See project 46 for example of proper connections.

OTHER PARTS

The disc holder and discs produce amazing effects when used with the Strobe Effects circuit (project 46).

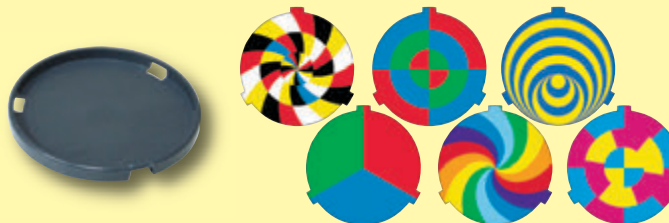

The LED attachments can be used with any of the LEDs (red, white, color, and the color organ) to enhance the light effects.



Fiber Optic Tree

Egg

Light Tower

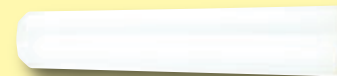

The fiber optic cable carries light between two places. The light can be encoded to transmit information. The clear and black holders are used to attach it to circuits.



The stereo cable is used to connect your music device to the color organ (U22).



Prismatic film separates light into different colors. The red, green, & blue filters filter out colors.

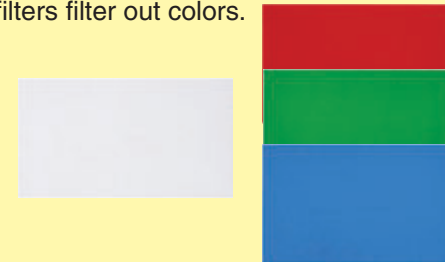

Introduction to Electricity

What is electricity? Nobody really knows. We only know how to produce it, understand its properties, and how to control it. Electricity is the movement of sub-atomic charged particles (called **electrons**) through a material due to electrical pressure across the material, such as from a battery.

Power sources, such as batteries, push electricity through a circuit, like a pump pushes water through pipes. Wires carry electricity, like pipes carry water. Devices like LEDs, motors, and speakers use the energy in electricity to do things. Switches and transistors control the flow of electricity like valves and faucets control water. Resistors limit the flow of electricity.

The electrical pressure exerted by a battery or other power source is called **voltage** and is measured in **volts** (V). Notice the “+” and “-” signs on the battery; these indicate which direction the battery will “pump” the electricity.

The **electric current** is a measure of how fast electricity is flowing in a wire, just as the water current describes how fast water is flowing in a pipe. It is expressed in **amperes** (A) or **milliamps** (mA, 1/1000 of an ampere).

The “**power**” of electricity is a measure of how fast energy is moving through a wire. It is a combination of the voltage and current (Power = Voltage x Current). It is expressed in **watts** (W).

The **resistance** of a component or circuit represents how much it resists the electrical pressure (voltage) and limits the flow of electric current. The relationship is Voltage = Current x Resistance. When the resistance increases, less current flows. Resistance is measured in **ohms** (Ω), or **kilo ohms** ($k\Omega$, 1000 ohms).

Nearly all of the electricity used in our world is produced at enormous generators driven by steam or water pressure. Wires are used to efficiently transport this energy to homes and businesses where it is used. Motors convert the electricity back into mechanical form to drive machinery and appliances. The most important aspect of electricity in our society is that it allows energy to be easily transported over distances.

Note that “distances” includes not just large distances but also tiny distances. Try to imagine a plumbing structure of the same complexity as the circuitry inside a portable radio - it would have to be large because we can't make water pipes so small. Electricity allows complex designs to be made very small.

There are two ways of arranging parts in a circuit, in series or in parallel. Here are examples:

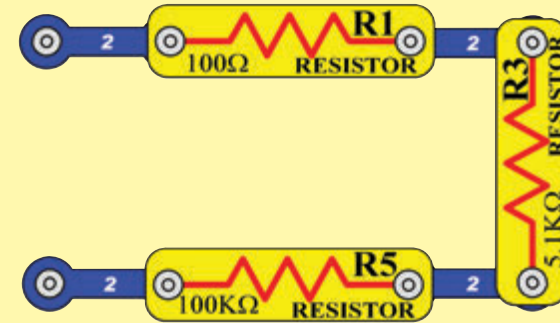

Series Circuit

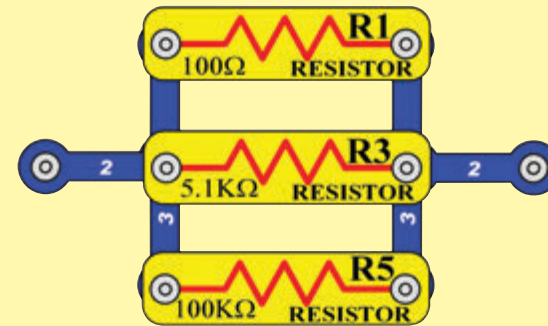

Parallel Circuit

Placing components in series increases the resistance; highest value dominates. Placing components in parallel decreases the resistance; lower value dominates.

The parts within these series and parallel sub-circuits may be arranged in different ways without changing what the circuit does. Large circuits are made of combinations of smaller series and parallel circuits.

Light in Our World

What would our world be like without light? Moving and doing things in total darkness would be much more difficult, because everyone would be blind. Plants rely on sunlight for energy and would die without it. If all the plants die, then people and animals would have nothing to eat, and would starve. Let's hope we never have to live in a world without light.

Light is energy, traveling at high speed. Sunlight can warm up your skin, as can bright lights in a concert hall or playhouse. Light can carry information. For example, our brains analyze the light received in our eyes, to learn what is around us. In fiber optic cables, beams of light carry data between cities. Infrared light from a remote control can tell a TV to change to a different channel.

Light moves as super-tiny charges, which are so full of energy they go flying off in all directions.

This happens when a material has too much energy, and some of the energy changes form. For example, a light bulb makes light when an electric current makes the filament so hot that it glows. Some of the energy in a burning fire escapes by changing to light. Our bright sun makes so much light because it is basically a gigantic ball of thermonuclear reactions. Light emitting diodes (LEDs) make light by converting excess electrical energy.

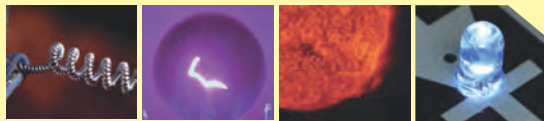

Light bulb filament

Glowing light bulb filament

Close-up view of the Sun

Glowing white LED (D6)

You "see" when light enters your eyes. When you turn on a light in a room, the light shines on everything around it. When light shines on something, some of the light is absorbed into it, and the rest is reflected off. The absorbed light is converted to heat, and the reflected light is scattered around the room. Some of the shining and reflected light might reach your eyes. Your brain interprets the light into your eyes, and makes the mental picture you see.

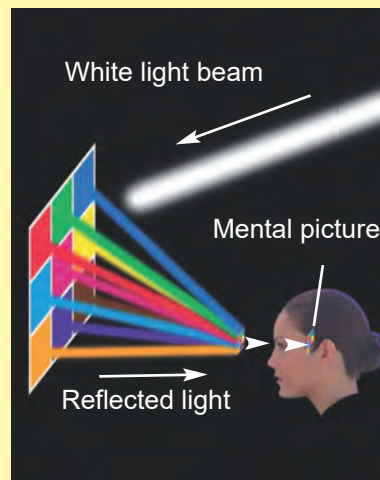

When all the light shining on something is absorbed, with none reflected towards your eyes, then you can't see it. The object will appear dark. The brighter an object appears, the more light was reflected off it and into your eyes. Some materials, like air and clear glass, let light pass through them.

You can only see the moon when light from the sun bounces off it, and reflects to earth.



You can't see a beam of light traveling across a room, unless something scatters the light and some reaches your eyes. In a dusty room, sometimes you can see the dust particles floating in the air when sunlight hits them.

In this photograph, sand has been tossed into the air, which is illuminated by a narrow beam of sunlight coming down into the canyon.



When you turn on a light, you instantly see everything. This happens because light is very fast, and

travels about 299 338 km a second in air.

Light rays can bend when they pass between different materials, such as air and water. Light bends because its speed changes. The speed of light in water is only about 201 168 km a second.

The part of the pen in water looks distorted, because light changes speed when entering and leaving the water.



When you look directly out a glass window, you can see clearly through it. When you look through the window at a wide angle, you can see through it, but also see a reflection in it.

When you try to look through the window at a really wide angle, you can't see through it at all, and only see reflections. Try looking through a window in your home at really wide angles.

Light in Our World

When light hits a glass surface at a wide enough angle, all the light is reflected. Fiber optic cables have arrays of flexible glass fibers. In these cables, light rays move through by bouncing along the inside walls at wide angles, and can travel great distances. Light moves through the cable even if it is bent a little, but if there is a tight bend then most of the light will be absorbed instead of reflected forward.

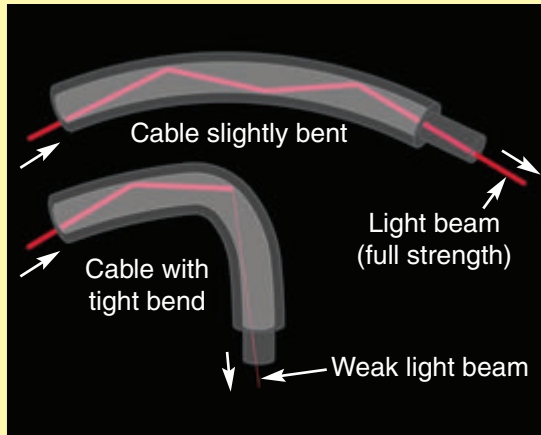

Translucent materials, such as the tower and egg LED attachments in this set, allow some light to pass through but scatter it around.

Color

The things around you have different colors because they reflect the colors that you see, while absorbing the other colors. Light produced by the sun or a light bulb is called white light. White light is not really a color itself, but is a mixture of all the colors seen in a rainbow.

When white light shines on an orange, all colors in the light are absorbed except orange, which is reflected off. The reflected orange light reaches our eyes, so we see it as having orange color.

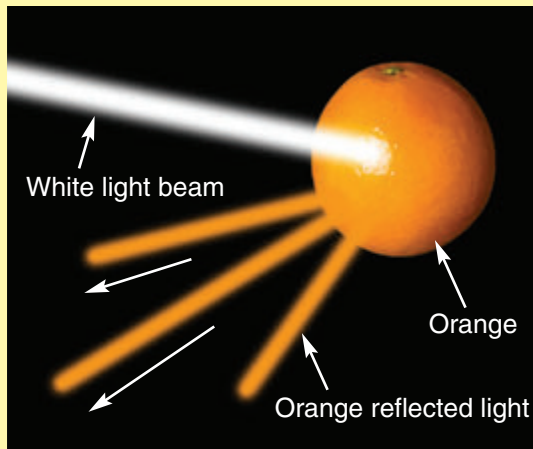

White light can be split up into its different colors. This happens when light passes between different materials, and the different colors in it are bent by different amounts. You can see this by viewing white light through prismatic film, as you do in project 67. Sometimes water in the air can bend sunlight by just the right amounts, and make a rainbow.

Color filters allow one color to pass through, and absorb the other colors. When you look through a red filter, everything looks red (or black, if there isn't any red in what you are looking at). This set includes red, green, and blue filters, so try looking through them.

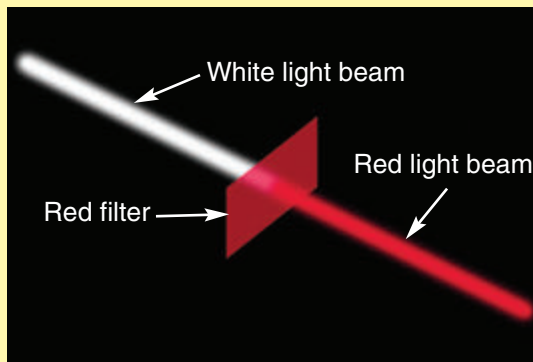

Any color of light can be made, by mixing different amounts of red, green, and blue light. Mixing equal amounts of these colors produces white light. If you look at a TV screen with a magnifying glass, you will see it actually consists of tiny red, green, and blue lights, using different intensities to make all the colors.

This set includes several LEDs (D1, D6, D8, and in U22) with different colors. The color emitted by an LED depends on the material used in it. LEDs are more energy-efficient than incandescent light bulbs, can be made smaller, and last longer.

The LED in the color organ module (U22) contains separate red, green, and blue LEDs. The color organ can combine these colors to make yellow, cyan, purple, and white, as shown in project 6. The color organ does not allow you to adjust the amount of each color. In project 49, several colors are mixed together on a spinning disc.

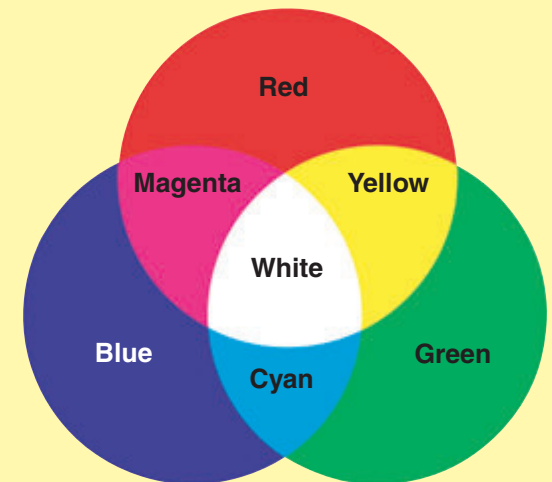

Light in Our World

The Spectrum of Light

The light our eyes see is only part of what is around us. Visible light, infrared light, radio waves (including TV broadcasting and cell phones), microwaves, and x-rays are all forms of electromagnetic radiation. They are actually changing electric and magnetic fields. This radiation travels like waves in water, spreading out from where it was created. These waves all travel at the speed of light, but some are longer (higher wavelength) and some repeat faster (higher frequency). Together they are called the electromagnetic spectrum:

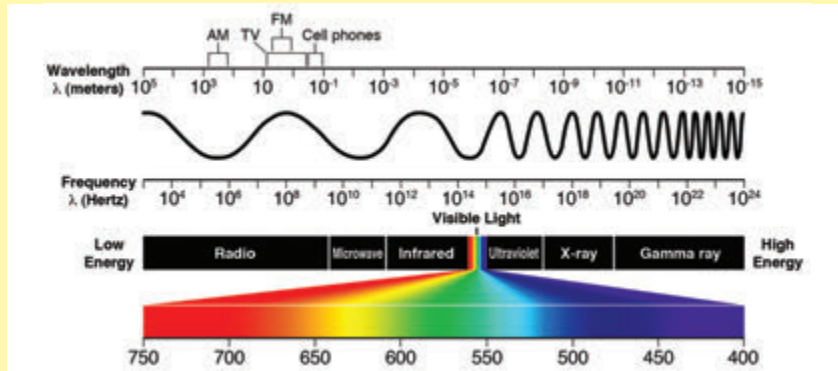

The visible colors (red, orange, yellow, green, blue, and violet) have different wavelengths. In the right conditions white light from the sun can be separated according to wavelength, producing a rainbow of color. This happens with an actual rainbow, and with prismatic film.

Why is the sky blue? Some sunlight is scattered by tiny particles in the earth's atmosphere. The shorter wavelength blue light is scattered more than the other colors, so the sky appears blue. At sunrise or sunset,

longer wavelength colors like red or yellow are more visible in the sky, because sunlight passes through more of the atmosphere before reaching your eyes. In space, the sky always appears black because there is no atmosphere or scattering effect.

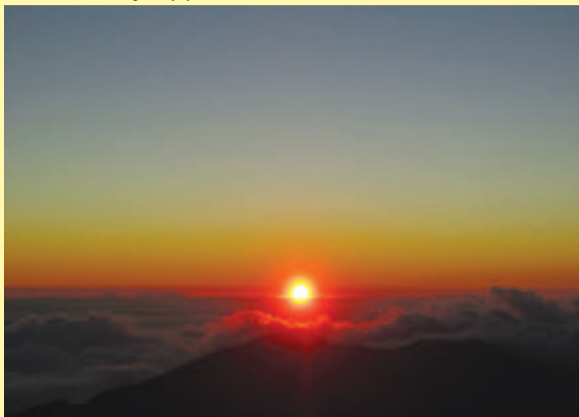

Infrared

Infrared light is invisible light given off by anything warm. Infrared is used in remote controls to control TVs and appliances. Infrared is invisible, so it doesn't disrupt your view of the TV. Infrared doesn't go through walls, so it doesn't interfere with devices in other rooms.

The remote control sends a stream of infrared light pulses to the TV, encoded with the desired commands. The infrared light is created using an infrared light emitting diode (LED). Infrared detectors convert the received light to electric current, and decode the commands. The detectors are tuned to focus on the infrared light, and ignore visible light. This set contains an infrared detector (U24), which can be activated by a TV remote control; see projects 41 and 42 for examples.

Infrared has other uses such as night vision devices help to see people and animals in the dark, by looking at the heat they give off as infrared light. You probably saw this in the movies.

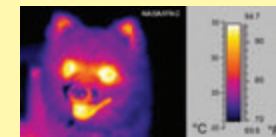
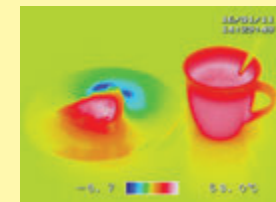
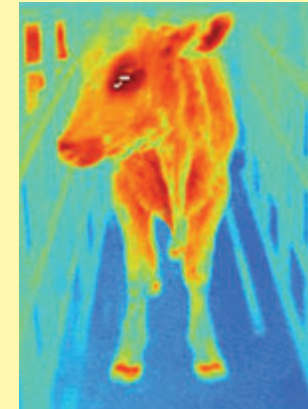

Glow-in-the-dark

Some materials can absorb light, store it for a while, and slowly release it back out. "Glow-in-the-dark" materials can be "charged" by bright light, then will slowly emit light and "glow" for a while in a dark room. The glow fan blade in this set has a glow powder mixed in the plastic. It's like a slow, delayed reflection of the light.

Sound

Sound, like light, spreads out like waves from where it was made. Sound is variations in air pressure. You "hear" sound when your ears feel these air pressure variations. Sound has much longer wavelength than light, which enables sound to travel around corners. Sound can also be thought of as a wave of vibration, and can travel through water and solid objects. Sound travels about 1,000 feet per second in air, and about 5,000 feet per second in water.

DO's and DON'Ts of Building Circuits

After building the circuits given in this booklet, you may wish to experiment on your own. Use the projects in this booklet as a guide, as many important design concepts are introduced throughout them. Every circuit will include a power source (the batteries), a resistance (which might be a resistor, capacitor, motor, integrated circuit, etc.), and wiring paths between them and back. **You must be careful not to create "short circuits" (very low-resistance paths across the batteries, see examples at right) as this will damage components and/or quickly drain your batteries.** Only connect the color organ (U22), strobe IC (U23) and infrared module (U24) using configurations given in the projects, incorrectly doing so may damage them. **ConQuest entertainment is not responsible for parts damaged due to incorrect wiring.**

Here are some important guidelines:

- ALWAYS** USE EYE PROTECTION WHEN EXPERIMENTING ON YOUR OWN.
- ALWAYS** include at least one component that will limit the current through a circuit, such as the speaker, capacitors, ICs (which must be connected properly), motor, microphone, phototransistor, or resistors.
- ALWAYS** use LEDs, transistors, and switches in conjunction with other components that will limit the current through them. Failure to do so will create a short circuit and/or damage those parts.
- ALWAYS** connect capacitors so that the "+" side gets the higher voltage.
- ALWAYS** disconnect your batteries immediately and check your wiring if something appears to be getting hot.
- ALWAYS** check your wiring before turning on a circuit.
- ALWAYS** connect the color organ (U22), strobe IC (U23) and infrared module (U24) using configurations given in the projects or as per the connection description on page 8.
- NEVER** connect to an electrical outlet in your home in any way.
- NEVER** leave a circuit unattended when it is turned on.
- NEVER** touch the motor when it is spinning at high speed.

For all of the projects given in this book, the parts may be arranged in different ways without changing the circuit. For example, the order of parts connected in series or in parallel does not matter — what matters is how combinations of these sub-circuits are arranged together.

You are encouraged to tell us about new programs and circuits you create.

If they are unique, we will post them with your name and state on our website at: www.toy.cz. Send your suggestions to ConQuest entertainment: info@toy.cz.

Examples of SHORT CIRCUITS - NEVER DO THESE!!!

Placing a 3-snap wire directly across the batteries is a SHORT CIRCUIT.



NEVER DO!

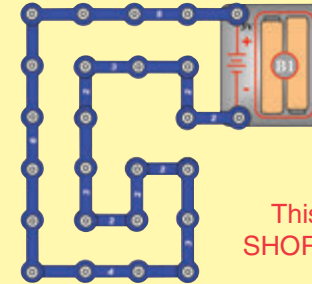
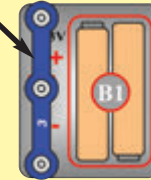

NEVER DO!

This is also a SHORT CIRCUIT.

When the slide switch (S1) is turned on, this large circuit has a SHORT CIRCUIT path (as shown by the arrows). The short circuit prevents any other portions of the circuit from ever working.

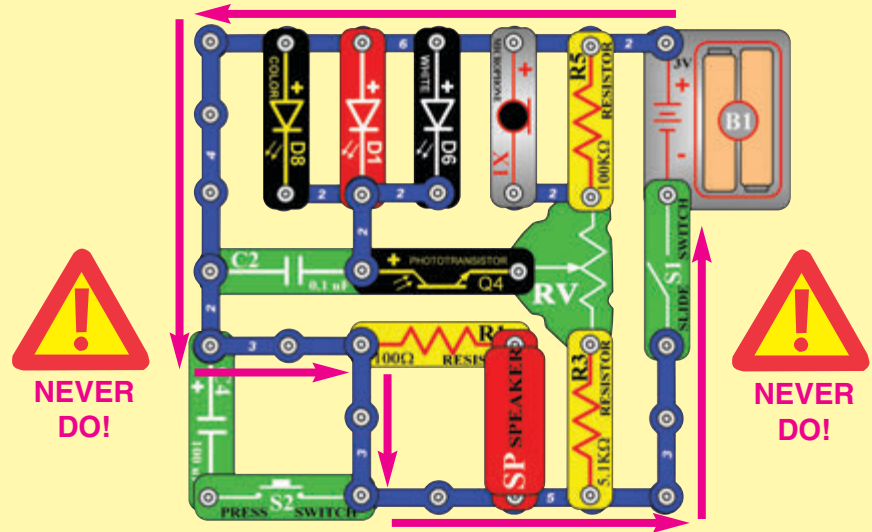

NEVER DO!



NEVER DO!



WARNING: SHOCK HAZARD - Never connect Boffin to the electrical outlets in your home in any way!



Warning to Boffin owners: Do not use parts from other Boffin sets with this kit. Other sets use higher voltage which could damage parts.

Advanced Troubleshooting (Adult supervision recommended)

If you suspect you have damaged parts, you can follow this procedure to systematically determine which ones need replacing:

(Note: Some of these tests connect an LED directly across the batteries without another component to limit the current. Normally this might damage the LED, however Boffin LEDs have internal resistors added to protect them from incorrect wiring, and will not be damaged.)

- Red LED (D1), motor (M1), speaker (SP), and battery holder (B1):** Place batteries in holder. Place the red LED directly across the battery holder (LED + to battery +), it should light. Do the same for the motor, it should spin. "Tap" the speaker across the battery holder contacts, you should hear static as it touches. If none work, then replace your batteries and repeat. If still bad, then the battery holder is damaged. If the motor spins but does not balance the fan, check the black plastic piece with three prongs on the motor shaft, and replace it if it is damaged (this kit includes a spare). To replace, pry the broken one off the motor shaft using a screwdriver, then push the new one on.
- Red & black jumper wires:** Use this mini-circuit to test each jumper wire, the LED should light.

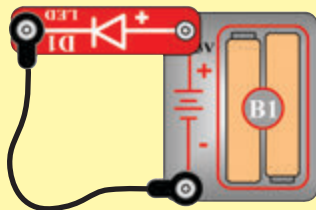

- Snap wires:** Use this mini-circuit to test each of the snap wires, one at a time. The LED should light.

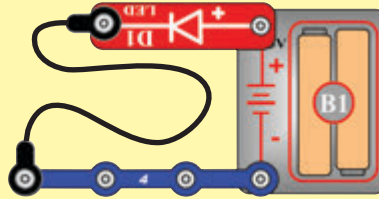

- Slide switch (S1) and Press switch (S2):** Use this mini-circuit; if the LED doesn't light then the slide switch is bad. Replace the slide switch with the press switch to test it.

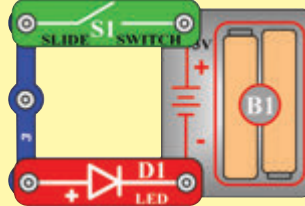

- 100Ω (R1) and 5.1kΩ (R3) resistors:** Use the mini-circuit from test 4 but replace the switch with the 100Ω resistor (R1); the LED will be bright if the resistor is good. Next use the 5.1kΩ resistor in place of the 100Ω resistor; the LED should be much dimmer but still light.
- White LED (D6) and color LED (D8):** Use this mini circuit; if the white LED doesn't light then D6 is bad. Replace the white LED with the color LED; it should change colors in a repetitive pattern, otherwise D8 is bad.

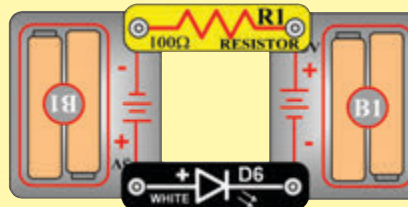

- Microphone (X1) and Phototransistor (Q4):** Use the mini-circuit from test 6 but replace the 100Ω resistor with the microphone (X1, + on right); if blowing into the microphone does not change the LED brightness then X1 is bad. Replace the microphone with the phototransistor. Waving your hand over the phototransistor (changing the light that shines on it) should change the brightness of the LED or Q4 is bad.
- Adjustable resistor (RV):** Build project 162, but use the red LED (D1) in place of the color LED (D8). Move the resistor control lever to both sides. When set to each side, one LED should be bright and the other off (or very dim); otherwise RV is bad.
- PNP transistor (Q1):** Build the mini-circuit shown here. The red LED (D1) should only be on if the press switch (S2) is pressed. If otherwise, then Q1 is damaged.

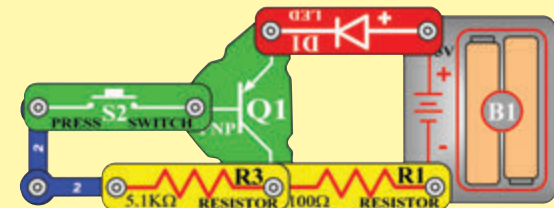

- NPN transistor (Q2):** Build the mini-circuit shown here. The red LED (D1) should only be on if the press switch (S2) is pressed. If otherwise, then Q2 is damaged.

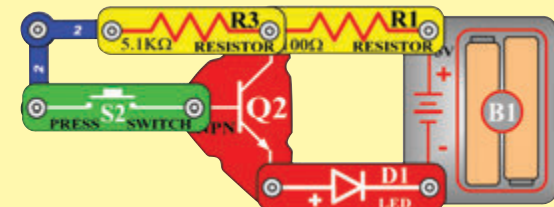

Advanced Troubleshooting (Adult supervision recommended)

11. **Strobe IC (U23) and 100kΩ resistor (R5):** Build the mini-circuit shown here, and turn on the switch (S1). The speaker should make a buzzing sound or U23 is bad. Next use the 100kΩ resistor in place of the 5.1kΩ resistor; the sound should be a beeping sound now or R5 is bad.

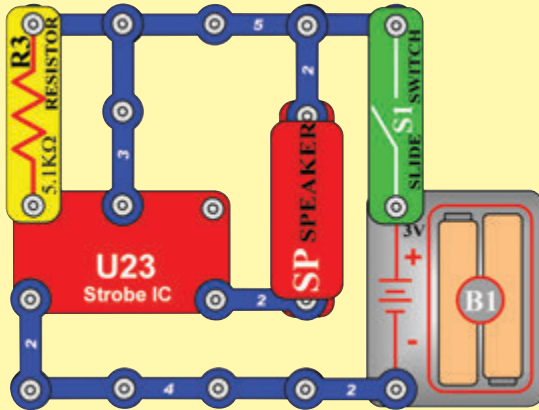

12. **Infrared module (U24):** Build project 41, the remote control should turn the red LED (D1) on; otherwise U24 is bad.

13. **0.1μF capacitor (C2) and 100μF capacitor (C4):** Build this circuit. There should be a buzzing sound, or C2 is bad. Next, replace C2 with C4; now you should hear beeps every 5 seconds, or C4 is bad. The setting on RV does not matter.

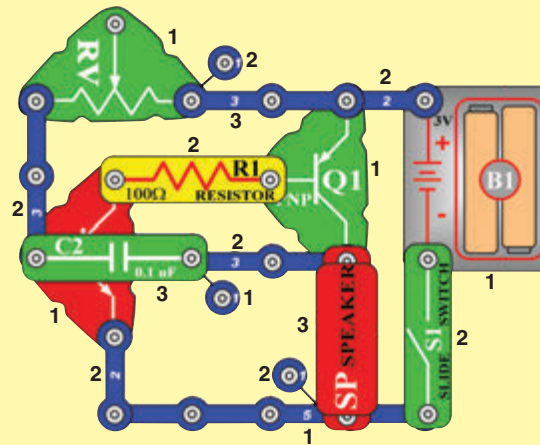

15. **Color organ (U22):** Do project 183. If parts A or B do not work, U22 is damaged. If part C does not work, then there may be a problem with U22, with your stereo cable, with your music device, or you may not have your music device on the right settings.

ConQuest entertainment a. s.
 Kolbenova 961, 198 00 Praha 9
 Tel: 284 000 111
 www.boffin.cz
 www.toy.cz
 info@boffin.cz

Project Listings

| Project | Description | Page | Project | Description | Page | Project | Description | Page |
|---------|-----------------------------------|------|---------|------------------------------------|------|---------|------------------------------|------|
| 1 | Color Light | 18 | 32 | Automatic Light | 31 | 63 | Resistors & LEDs | 42 |
| 2 | White Light | 18 | 33 | Color Oscillator | 31 | 64 | Low Power Brightness Control | 43 |
| 3 | Red Light | 18 | 34 | Dance to the Music | 32 | 65 | Low Power Resistors & LEDs | 43 |
| 4 | Light Show | 19 | 35 | Super Dance to the Music | 32 | 66 | Persistence of Vision | 43 |
| 5 | Voice Light Show | 20 | 36 | Super Dance to the Music (II) | 32 | 67 | Prismatic Film | 44 |
| 6 | Play the Color Organ | 20 | 37 | Follow the Music | 33 | 68 | Look at the Lights | 44 |
| 7 | Flying Saucer | 21 | 38 | Color Organ - Headphones | 33 | 69 | Scattering Light | 44 |
| 8 | Super Flying Saucer | 21 | 39 | Adjustable Light Dance | 34 | 70 | Color Fiber Light | 44 |
| 9 | Big Circuit | 22 | 40 | Suspended Raindrops | 34 | 71 | One Way Plastic | 45 |
| 10 | Box Cover Circuit | 23 | 41 | Infrared Detector | 35 | 72 | White Blinker | 45 |
| 11 | Blinking Colors | 24 | 42 | Audio Infrared Detector | 35 | 73 | Red Blinker | 45 |
| 12 | Fiber Optics | 24 | 43 | Photo Infrared Detector | 36 | 74 | Red & White | 45 |
| 13 | Tones Over Light | 25 | 44 | Photo Audio Infrared Detector | 36 | 75 | Color Selector - Red | 46 |
| 14 | Color Optic Sounds | 25 | 45 | Photo Audio Infrared Detector (II) | 36 | 76 | Color Selector - Green | 46 |
| 15 | Color Light | 26 | 46 | Strobe Effects | 37 | 77 | Color Selector - Blue | 46 |
| 16 | Color Optics | 26 | 47 | Slow Strobe Effects | 37 | 78 | Color Selector - Cyan | 46 |
| 17 | High Power Fiber Optics | 27 | 48 | Stable Strobe Effects | 38 | 79 | Color Selector - Yellow | 46 |
| 18 | High Color Optics Sounds | 27 | 49 | Strobe Effects (II) | 38 | 80 | Color Selector - Purple | 46 |
| 19 | Sound Maker | 28 | 50 | Strobe Effects (III) | 38 | 81 | Color Selector - White | 46 |
| 20 | Strobe Light | 28 | 51 | Strobe Effects (IV) | 38 | 82 | LED Color Spectrum | 47 |
| 21 | Color Strobe Light | 28 | 52 | Strobe Effects (V) | 38 | 83 | LED Color Spectrum (II) | 47 |
| 22 | Red Strobe Light | 28 | 53 | Strobe Effects (VI) | 39 | 84 | LED Color Spectrum (III) | 47 |
| 23 | Noisy Strobe Light | 29 | 54 | Make Your Own Strobe Effects | 39 | 85 | LED Color Spectrum (IV) | 47 |
| 24 | Noisy Red Strobe Light | 29 | 55 | Another Strobe Light | 39 | 86 | LED Color Spectrum (V) | 47 |
| 25 | Double Strobe Light | 29 | 56 | Motor Strobe Effects | 40 | 87 | Blinking Beeping | 48 |
| 26 | Louder Strobe Light | 29 | 57 | Motor Strobe Effects (II) | 40 | 88 | Blinking Blinking | 48 |
| 27 | Louder Color Strobe Light | 29 | 58 | Motor Strobe Effects (III) | 40 | 89 | Blinking Control | 48 |
| 28 | Triple Strobe Light | 30 | 59 | LEDs Together | 41 | 90 | Blinking Control Beeping | 48 |
| 29 | Noisy Double Strobe Light | 30 | 60 | LEDs Together (II) | 41 | 91 | Triple Blinker | 49 |
| 30 | Noisy Triple Strober | 30 | 61 | Brightness Control | 42 | 92 | Funny Speed Motor | 49 |
| 31 | Triple Light Noisy Motion Strober | 30 | 62 | Resistors | 42 | 93 | Funny Speed Motor with Light | 49 |

Project Listings

| Project | Description | Page | Project | Description | Page | Project | Description | Page |
|---------|-----------------------------|------|---------|-----------------------------------|------|---------|--------------------------------|------|
| 94 | Light Dance Audio Override | 50 | 125 | Wacky Buzzer | 58 | 156 | LEDs & Transistors | 71 |
| 95 | Light Dance Light Override | 50 | 126 | Fiber Fun | 59 | 157 | PNP Amplifier | 71 |
| 96 | Counting Light | 51 | 127 | Fiber Fun Backwards | 59 | 158 | Photo Control | 72 |
| 97 | Adjustable Counting Light | 51 | 128 | More Fiber Fun | 59 | 159 | Resistance Director | 72 |
| 98 | Bright Off Light | 52 | 129 | Other Fiber Fun | 59 | 160 | Current Controllers - Series | 73 |
| 99 | R/C Blink & Beep | 52 | 130 | Morse Code | 60 | 161 | Current Controllers - Parallel | 73 |
| 100 | Stuck On Light | 53 | 131 | Fiber Shut-Off | 60 | 162 | Blow Sound Changer | 74 |
| 101 | Stuck On Lights | 53 | 132 | Blow On Fiber | 61 | 163 | Short Light | 74 |
| 102 | White Blinker | 53 | 133 | Fiber Music | 61 | 164 | Shorter Light | 74 |
| 103 | Low Voltage Stuck On Lights | 53 | 134 | Fiber Color Organ | 62 | 165 | Photo Light Control | 75 |
| 104 | Stuck On Motor & Lights | 53 | 135 | Bright Fiber Color Organ | 62 | 166 | Air Pressure Light Control | 75 |
| 105 | Funky Light & Sound | 54 | 136 | Motor Power | 63 | 167 | Slow On, Slower Off Delayed | 75 |
| 106 | Light & Sound | 54 | 137 | More Motor Power | 63 | 168 | Photo Speed Control Delayed | 76 |
| 107 | Light & Motion | 54 | 138 | Reflection Detector | 63 | 169 | Speed Control Delayed | 76 |
| 108 | Adjustable Light & Sound | 54 | 139 | Cup & String Communication | 64 | 170 | Speed Control (II) Audio | 76 |
| 109 | Adjustable Light & Motion | 54 | 140 | Slow Motor Speed Control | 65 | 171 | Delayed Speed Control Photo | 76 |
| 110 | Blinking Step Motor | 55 | 141 | Slow Motor Start Aid | 65 | 172 | Speed Control | 76 |
| 111 | Blink Step Beep | 55 | 142 | Series Lights | 66 | 173 | Light Buzz | 77 |
| 112 | Day Blinker | 56 | 143 | Wacky Sound Control | 66 | 174 | Delay Lights | 77 |
| 113 | Night Blinker | 56 | 144 | Musical Shapes | 67 | 175 | Touch Light | 78 |
| 114 | Night Light Show | 56 | 145 | Human & Liquid Sounds | 67 | 176 | Narrow Range Tone | 78 |
| 115 | Daylight Light Show | 56 | 146 | Human & Liquid Light | 67 | 177 | Slow Off Lights | 78 |
| 116 | Buzzer | 57 | 147 | Blow On the Light | 68 | 178 | 3D Pictures | 79 |
| 117 | Light & Sound | 57 | 148 | Blow Off the Light | 68 | 179 | Infrared Optical Audio | 81 |
| 118 | Light & Motion | 57 | 149 | Transistor | 69 | 180 | Test the Color Organ | 81 |
| 119 | Adjustable Light & Motion | 57 | 150 | Another Transistor | 69 | | | |
| 120 | Light Up the Fan | 57 | 151 | Charging & Discharging | 70 | | | |
| 121 | High Power Buzzer | 58 | 152 | Mini Capacitor | 70 | | | |
| 122 | Buzz Fan | 58 | 153 | Adjustable Charging & Discharging | 70 | | | |
| 123 | Light & Motion | 58 | 154 | Mini Battery | 70 | | | |
| 124 | Step Beeper | 58 | 155 | Photo Current Amplifier | 71 | | | |



Project 1

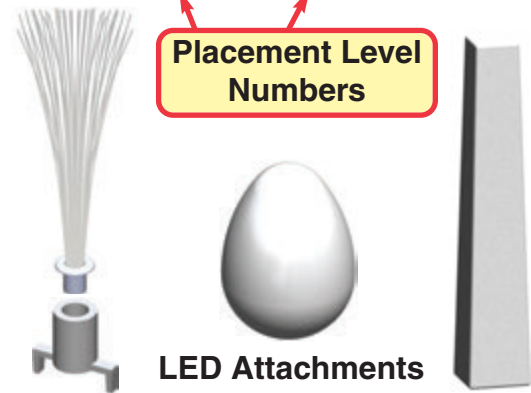
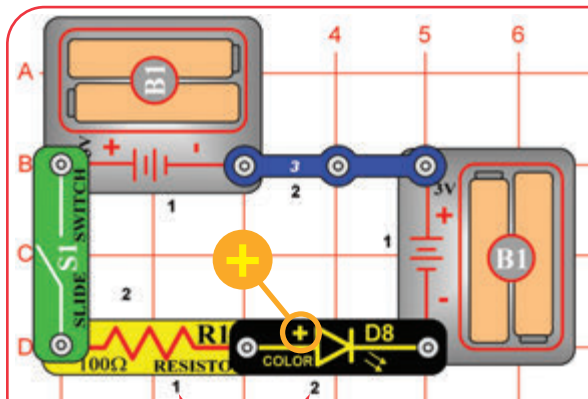

Placement Level Numbers

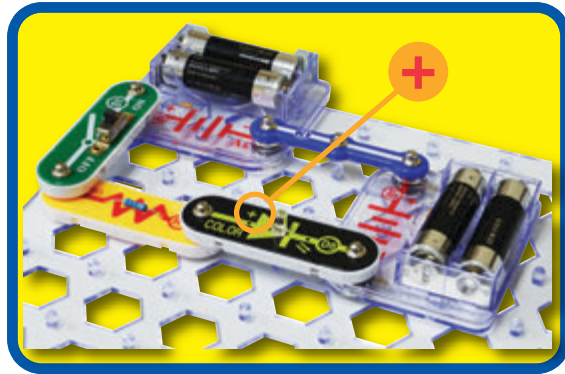

Snappy says the color LED actually contains separate red, green, and blue lights, with a micro-circuit controlling them.



Color Light

Boffin uses electronic blocks that snap onto a clear plastic grid to build different circuits. These blocks have different colors and numbers on them so that you can easily identify them.

Build the circuit shown on the left by placing all the parts with a black 1 next to them on the board first. Then, assemble parts marked with a 2. Install two (2) "AA" batteries (not included) into each of the battery holders (B1) if you have not done so already.

Turn on the slide switch (S1), and enjoy the light show from the color LED (D8). For best effects, place one of the LED attachments (tower, egg, or fiber optic tree) on the color LED, and dim the room lights. The fiber optic tree must be used with its mounting base.



Project 2 White Light

The white LED produces very bright light. LEDs like this one are increasingly being used for home lighting and flashlights. They are more efficient than normal light bulbs.

Use the circuit built in project 1, but replace the color LED (D8) with the white LED (D6). Try it with one of the LED attachments, and in a dark room.



Project 3 Red Light

The red LED is not nearly as bright as the other LEDs. LEDs like this one are used as indicators in many products in your home. They are inexpensive, but don't produce much light.

Use the circuit built in project 2, but replace the white LED (D6) with the red LED (D1). Try it with one of the LED attachments, and in a dark room.





Project 4

Light Show

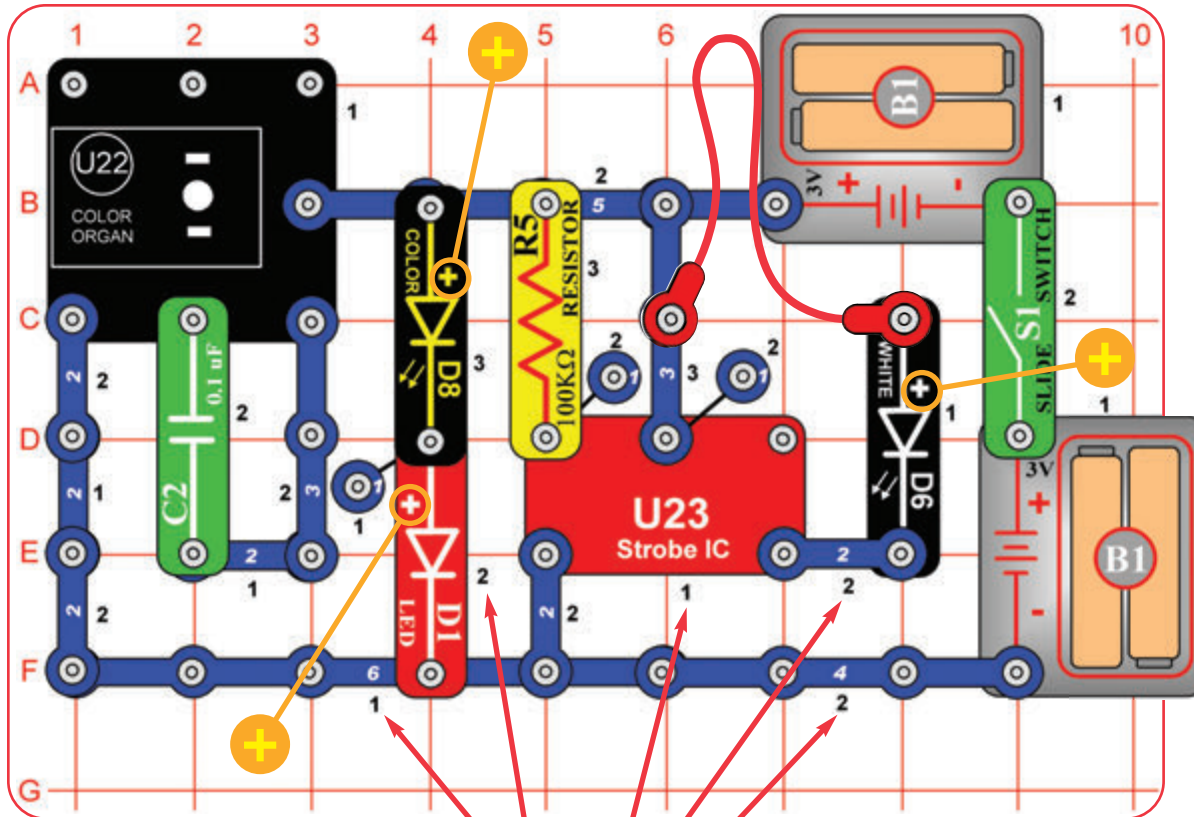

Boffin uses electronic blocks that snap onto a clear plastic grid to build different circuits. These blocks have different colors and numbers on them so that you can easily identify them.

Build the circuit shown above by placing all the parts with a black 1 next to them on the board first. Then, assemble parts marked with a 2. Then, assemble parts marked with a 3. Then, assemble parts marked with a 4 (just one end of the red jumper wire, in this circuit). Install two (2) "AA" batteries (not included) into each of the battery holders (B1) if you have not done so already.

If desired, place any of the LED attachments (tower, egg, or fiber optic tree) on any of the LEDs (red (D1), color (D8), white (D6), or the LED on the color organ IC (U22)). Note that the fiber optic tree requires its mounting base.

Turn on slide switch (S1) and enjoy the show!

Placement Level Numbers



LED Attachments

All the lights in this set are LEDs - Light Emitting Diodes. LEDs convert electrical energy into light; the color of the light emitted depends on the characteristics of the material used in them.





Project 5

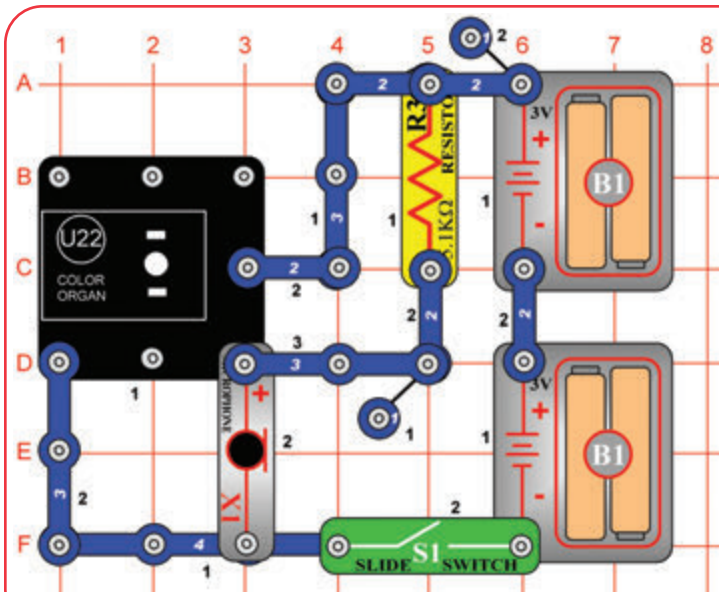

LED Attachments

Voice Light Show

Build the circuit as shown, and place one of the LED attachments (tower, egg, or fiber optic tree) over the LED on the color organ (U22). Turn on the switch (S1) and talk. The color organ light will follow your voice, in tone and loudness.

How does it work? The microphone converts your voice to an electrical signal, which controls an electronic counter in the color organ. The counter controls a red-green-blue LED.



Project 6

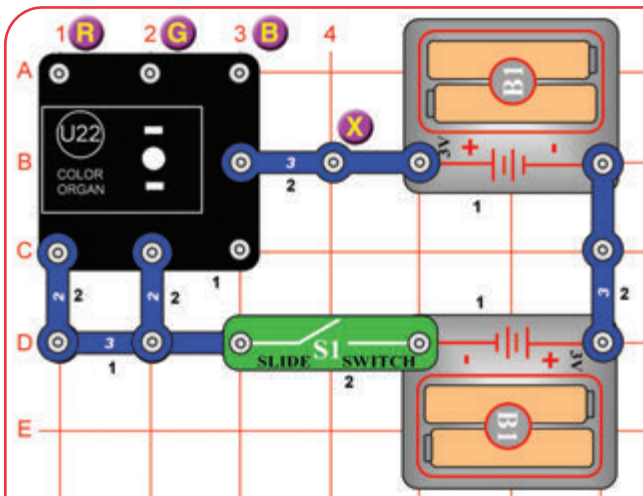

LED Attachments

Play the Color Organ

Build the circuit as shown, and turn on the switch (S1). Place one of the LED attachments on the color organ (U22). Wet your fingers, and touch them between the point marked "X", and points marked "R", "G", or "B" in the drawing. Try X with every combination of R, G, and B, including touching them all at the same time.

The light in the color organ module is actually red, green, and blue LEDs together. The points marked R, G, and B control the light for those colors. Combining red and green makes yellow, green and blue makes cyan, red and blue makes purple, and combining all three colors makes white.





Project 7

Flying Saucer

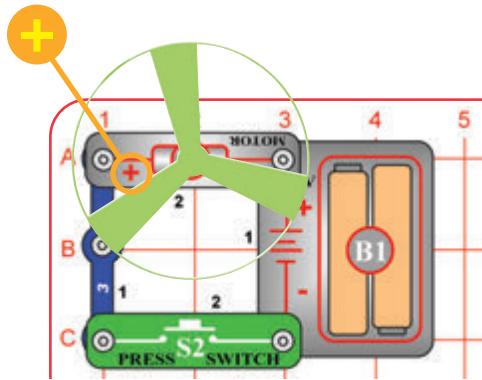

The air is being blown down through the blade and the motor rotation locks the fan on the shaft. When the motor is turned off, the blade unlocks from the shaft and is free to act as a propeller and fly through the air. If speed of rotation is too slow, the fan will remain on the motor shaft because it does not have enough lift to propel it.



Push the press switch (S2) until the motor reaches full speed, then release it. The fan blade should rise and float through the air like a flying saucer. Be careful not to look directly down on fan blade when it is spinning.

If the fan doesn't fly off, then press the switch several times rapidly when it is at full speed. The motor spins faster when the batteries are new.

The glow fan will glow in the dark. It will glow best after absorbing sunlight for a while. The glow fan is made of plastic, so be careful not to let it get hot enough to melt. The glow looks best in a dimly lit room.

WARNING: Moving parts. Do not touch the fan or motor during operation. Do not lean over the motor. Fan may not rise until switch is released.



Project 8

Super Flying Saucer

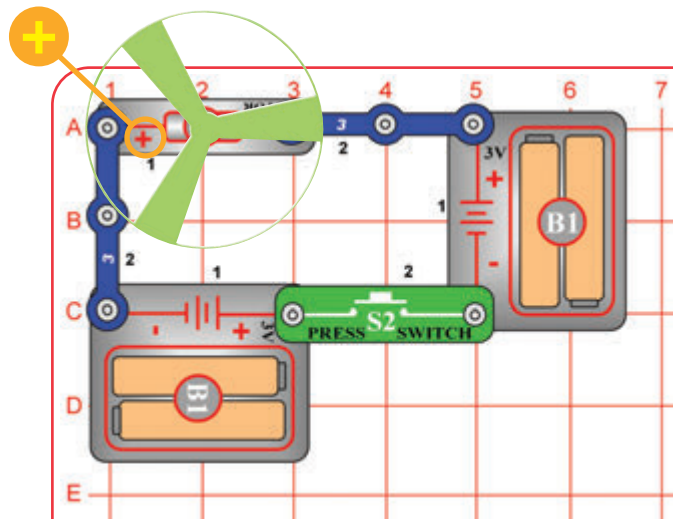

This circuit will make the fan spin faster and fly higher than the preceding circuit, making it easy to lose your fan.

WARNING: ConQuest entertainment is not responsible for lost or broken fans! You may purchase replacement fans at www.boffin.cz.

Push the press switch (S2) until the motor reaches full speed, then release it. The fan blade should rise and float through the air like a flying saucer. Be careful not to look directly down on fan blade when it is spinning.

If the fan doesn't fly off, then press the switch several times rapidly when it is at full speed. The motor spins faster when the batteries are new.

WARNING: Moving parts. Do not touch the fan or motor during operation. Do not lean over the motor. Fan may not rise until switch is released.



Project 9

Big Circuit

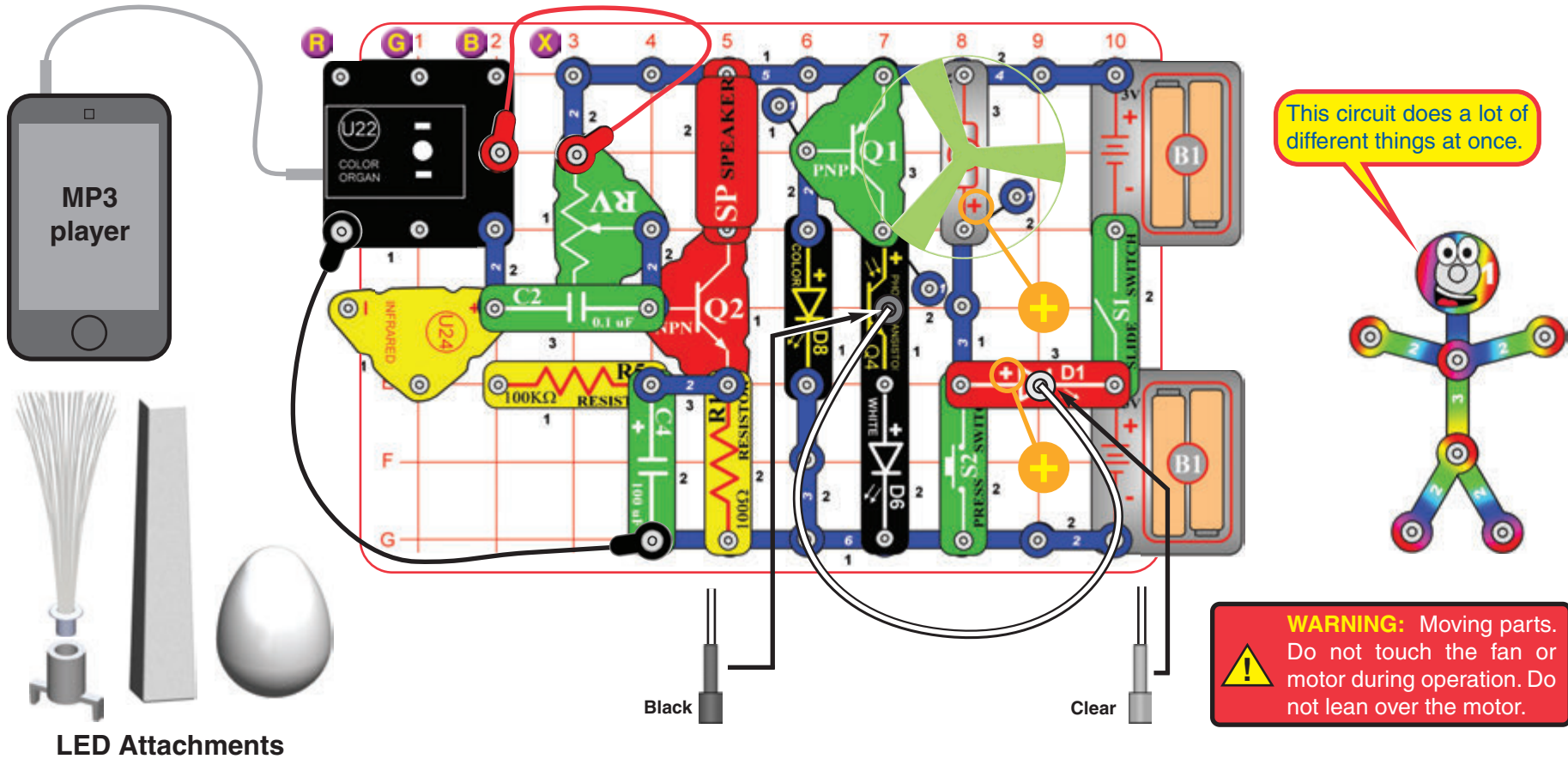

Build the circuit as shown. Place either the glow fan or the light fan on the motor (M1) shaft, so that it is stable on the little black piece. Place the clear fiber optic holder on the color LED (D8) and the black fiber optic holder on the phototransistor (Q4), then insert the fiber optic cable between them, but don't let it lay close to the fan on the motor. For best performance the fiber optic cable should stand straight up in the holders, without bending them. Connect a music device to the color organ (U22) as shown, and start music on it. For best effects, place one of the LED attachments over the light on the color organ.

Turn on slide switch (S1). Adjust the lever on the adjustable resistor (RV) and the volume control on your music device for best sound and light effects.

Push the press switch (S2) until the motor reaches full speed, then release it. The fan will rise into the air like a flying saucer. Be careful not to look down on the fan when it is spinning. If desired, connect the light fan blade to the charger for a while to charge it, then place it on the motor to spin or launch it.

“Playing the Color Organ”: turn off or disconnect your music device. Wet your fingers, and touch them between the point marked “X”, and “R”, “G”, or “B” in the drawing.

The infrared detector (U24) and 100kΩ resistor (R5) are only used to support the other components.



Project 10

Box Cover Circuit

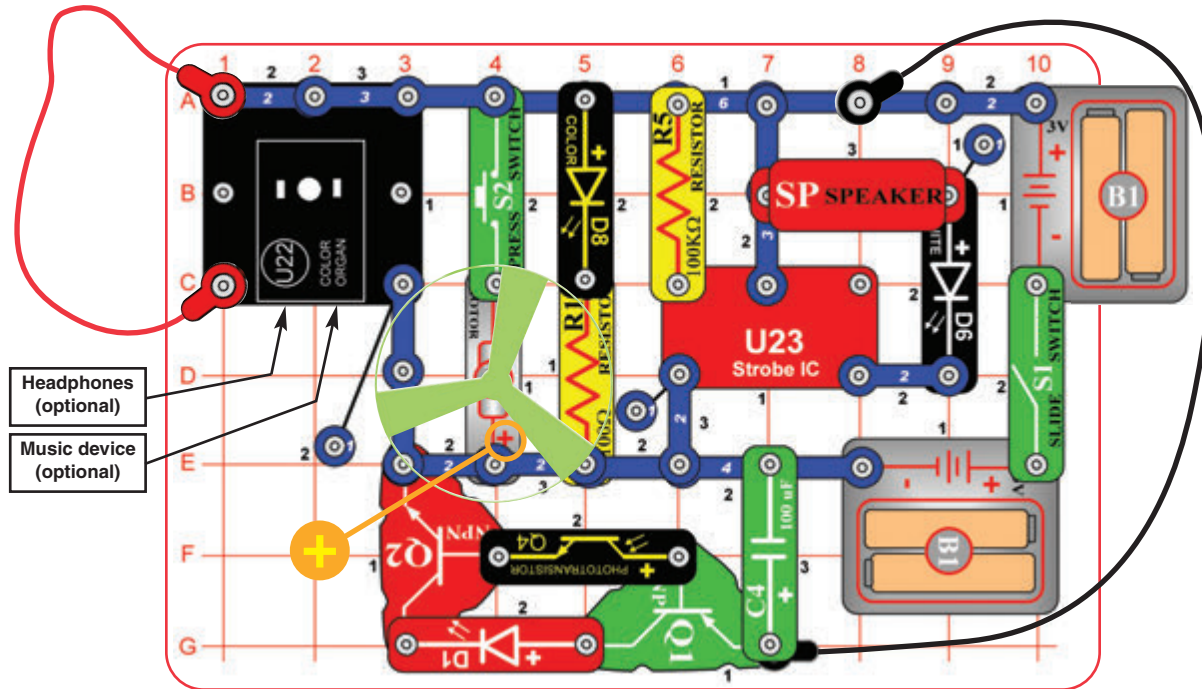

Build the circuit as shown. Place the glow fan on the motor (M1) shaft, so that it is stable on the little black piece. Place the clear fiber optic holder on the white LED (D6) and the black fiber optic holder on the phototransistor (Q4), then insert the fiber optic cable between them, but don't let it lay close to the fan on the motor. For best performance the fiber optic cable should stand straight up in the holders, without bending them. For best effects, place one of the LED attachments over the light on the color organ, and one on the color LED (D8).

Optional: connect a music device to the color organ (U22) as shown, and start music on it (the color organ light will change to the music, but you will not hear it unless you also connect headphones).

Turn on slide switch (S1). A tone is heard from the speaker (SP), and all the lights (D1, D6, D8, and on U22) are on.

Push the press switch (S2) until the motor reaches full speed, then release it. The fan will rise into the air like a flying saucer. Be careful not to look down on the fan when it is spinning.



WARNING: Moving parts. Do not touch the fan or motor during operation. Do not lean over the motor. Fan may not rise until switch is released.



Project 11

Blinking Colors

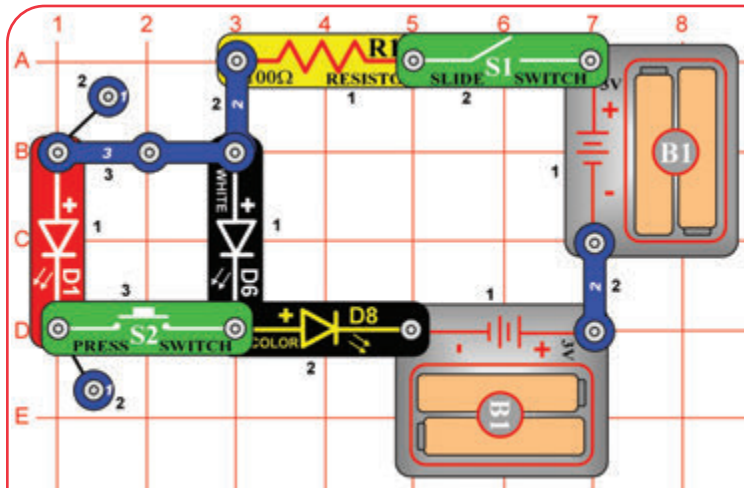

Red light is easier for LEDs to produce than white light. When the red and white LEDs are connected in parallel (which happens when S2 is pressed), the red LED will dominate because it turns on more easily.



Build the circuit as shown and turn on the slide switch (S1). The white and color LEDs (D6 & D8) are blinking.

Push the press switch (S2). Now the red LED (D1) is blinking but the white LED is off.

If you swap the locations of the red and white LEDs, then the red LED will be blinking and the white LED will be off, and pushing the press switch won't change anything.



Project 12

Fiber Optics

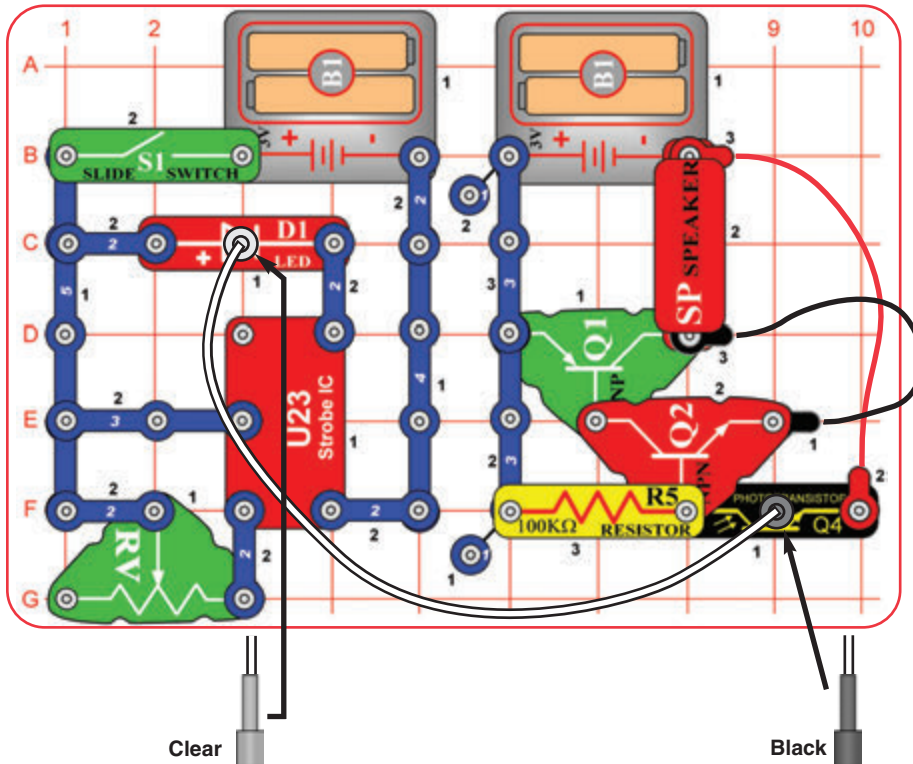

Build the circuit as shown. Place the clear cable holder on the red LED (D1) and the black cable holder on the phototransistor (Q4), then place the fiber optic cable into the holders as far as it will go. For best performance the cable should stand straight up in the holders, without bending them.

Turn on slide switch (S1) and move the lever on the adjustable resistor (RV) around. The sound from the speaker (SP) changes as you move the lever on RV.

This project is more exciting than it looks. The tone sounds produced by the strobe IC (U23) are played on the speaker (SP), even though there is no electrical connection between them.

The left half the circuit makes a coded light signal, which you see in the red LED (D1). The right half of the circuit decodes the light signal and plays it on the speaker. The fiber optic cable is used to transmit the light signal between the two sides of the circuit. There is no electrical connection between the left and right halves of the circuit, only a light connection using fiber optics! If your fiber optic cable was longer, the two halves of the circuit could be many miles apart.

This circuit is an example of using fiber optic cables for communication. Fiber optics allows information to be transmitted across great distances at very high speeds with very low distortion, by using light.



Project 13

Tones Over Light

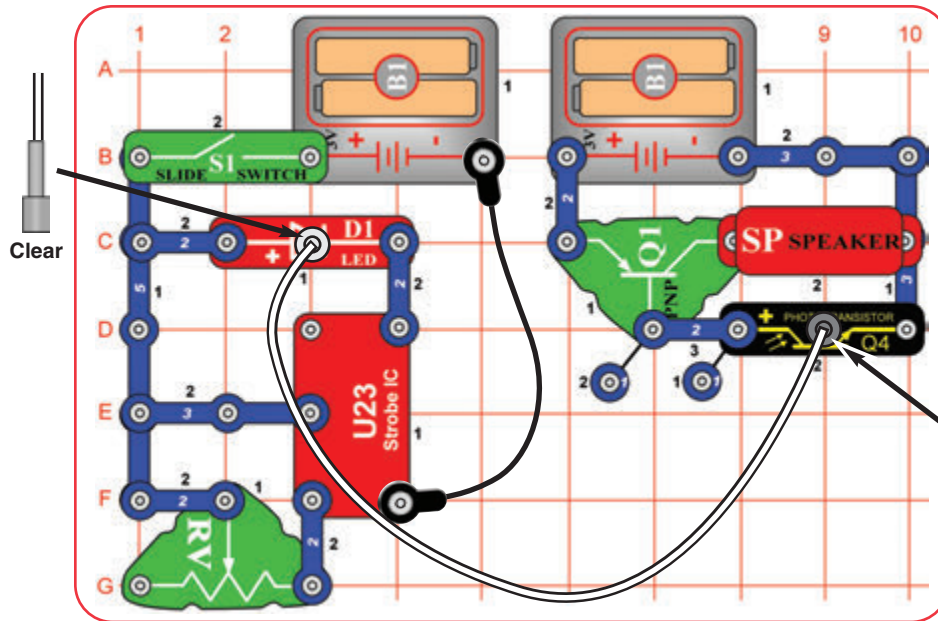

Build the circuit as shown. Place the clear cable holder on the red LED (D1) and the black cable holder on the phototransistor (Q4), then place the fiber optic cable into the holders as far as it will go. For best performance the fiber optic cable should stand straight up in the holders, without bending them.

Turn on the slide switch (S1) and move the lever on the adjustable resistor (RV) around. The sound from the speaker (SP) changes as you move the lever on RV.

This is similar to project 12 but not as loud. The project 12 circuit uses a two-transistor amplifier while this circuit only has one transistor.



Project 14

Color Optic Sounds

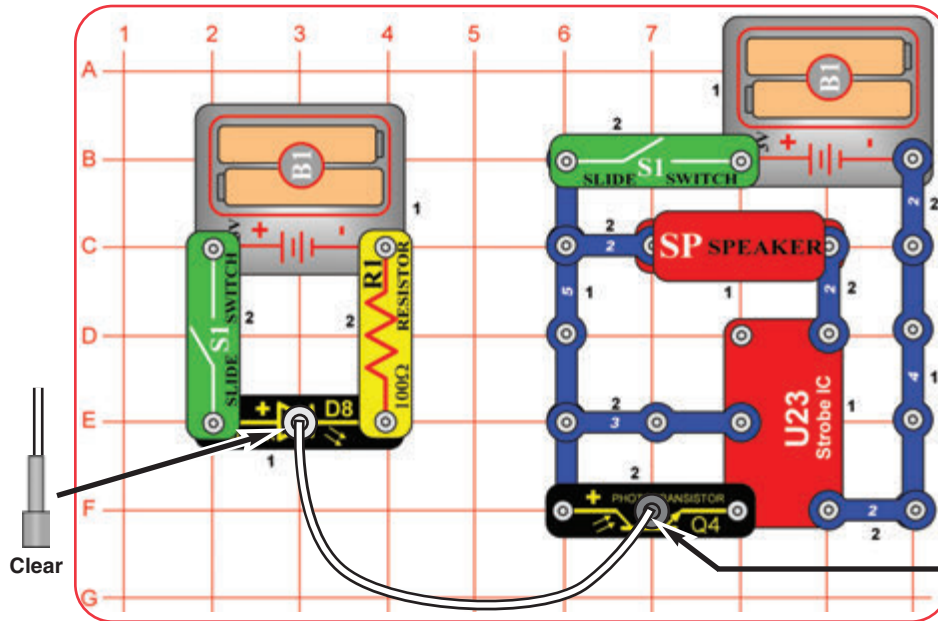

Build the circuit as shown. Place the clear cable holder on the color LED (D8) and the black cable holder on the phototransistor (Q4), then place the fiber optic cable into the holders as far as it will go. For best performance the fiber optic cable should stand straight up in the holders, without bending them.

Turn on the slide switch (S1). Light is transmitted from the color LED, through the fiber optic cable, to control the strobe IC (U23) and speaker (SP).



Project 15

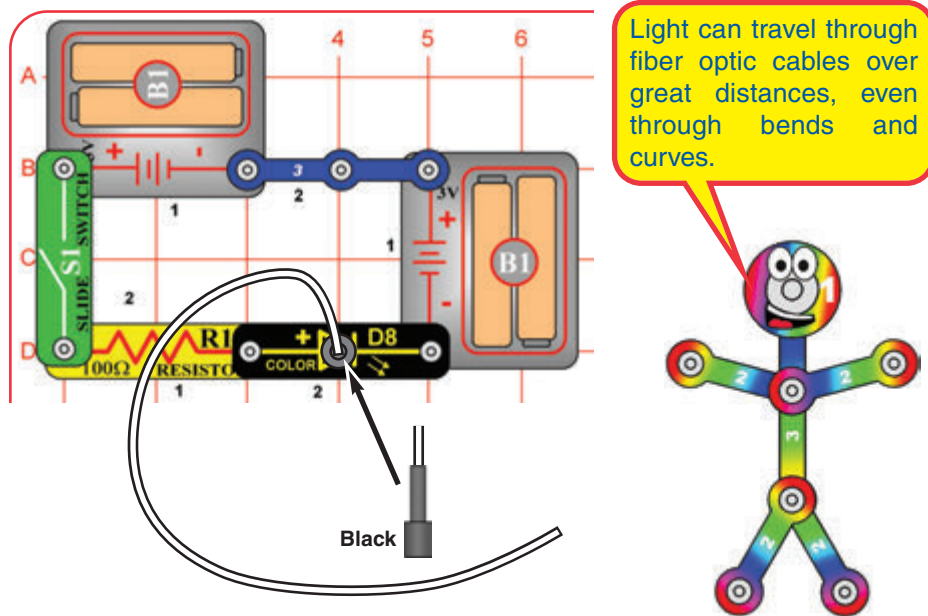

Color Light

Build the circuit as shown. Place the black cable holder on the color LED (D8), then place the fiber optic cable into the holder as far as it will go. For best performance the fiber optic cable should stand straight up in the holders, without bending them. Leave the other end of the cable free.

Turn on the switch (S1), and look into the loose end of the fiber optic cable. Flex the cable into loops but don't dent it. Take the circuit into a dark room and see how the cable looks.

You can use the clear cable holder on the color LED instead of the black holder.



Project 16

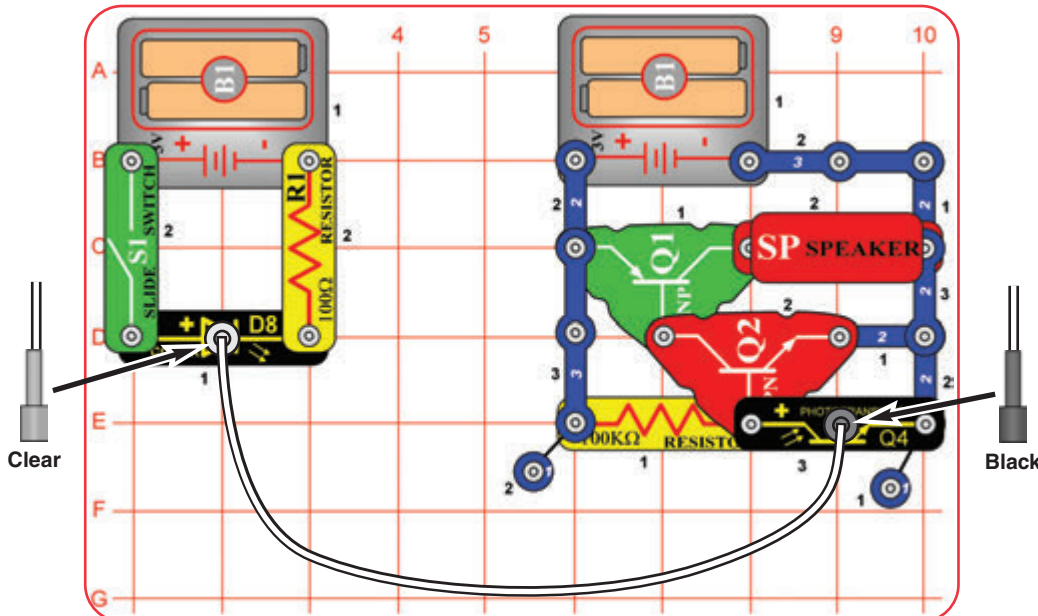

Color Optics

Build the circuit as shown. Place the clear cable holder on the color LED (D8) and the black cable holder on the phototransistor (Q4), then place the fiber optic cable into the holders as far as it will go. For best performance the fiber optic cable should stand straight up in the holders, without bending them.

Turn on the switch (S1). The color LED (D8) turns on and off repeatedly as it changes colors. This produces interesting effects when connected to the speaker circuit through the fiber optic cable.



Project 17

High Power Fiber Optics

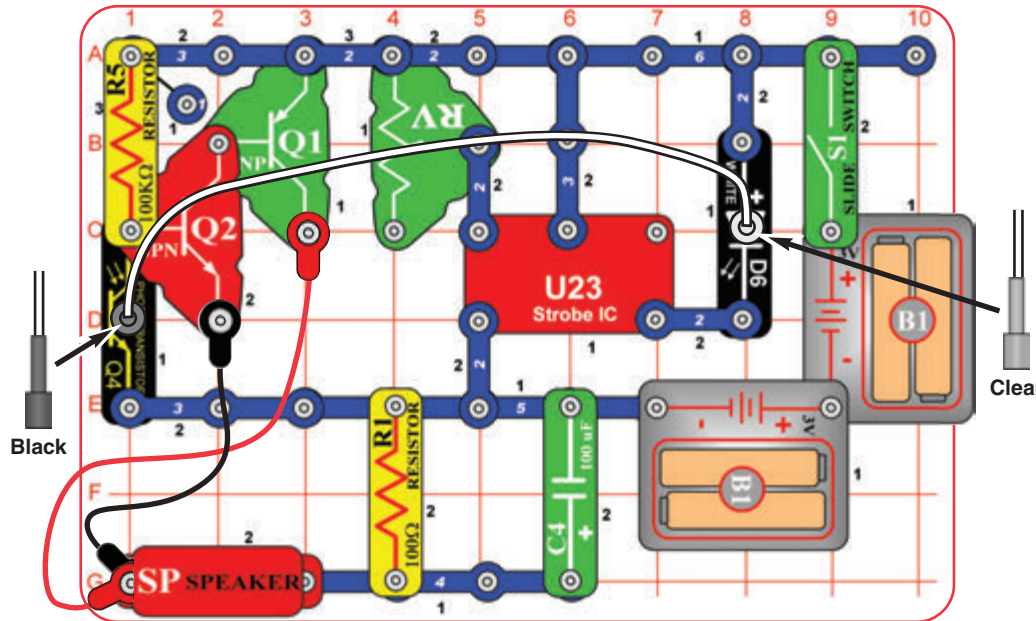

Build the circuit as shown. Place the clear cable holder on the white LED (D6) and the black cable holder on the phototransistor (Q4), then place the fiber optic cable into the holders as far as it will go. For best performance the fiber optic cable should stand straight up in the holders, without bending them.

Turn on the slide switch (S1) and move the lever on the adjustable resistor (RV) around. The sound from the speaker (SP) changes as you move the lever on RV.

Try removing the black cable holder and just holding the fiber optic cable next to the phototransistor with your fingers. Hold it at different angles and compare the sound. You may not hear anything, due to background light in the room. Take the circuit into a dark room or place your fingers around the phototransistor to block the room light to it. Now put the black cable holder back on, remove the clear cable holder, and try holding the fiber optic cable at different positions around the white LED. You can also replace the white LED with the red LED (D1) or the color LED (D8).



Project 18

High Color Optics Sounds

The circuits on this page are similar to projects 12 and 14, but have the fiber optic transmitting sub-circuit (with the LED) and the receiving sub-circuit (with the phototransistor) using the same voltage sources. Normally the transmitting and receiving circuits will be in different locations with separate voltage sources, but they were combined here to increase the power.

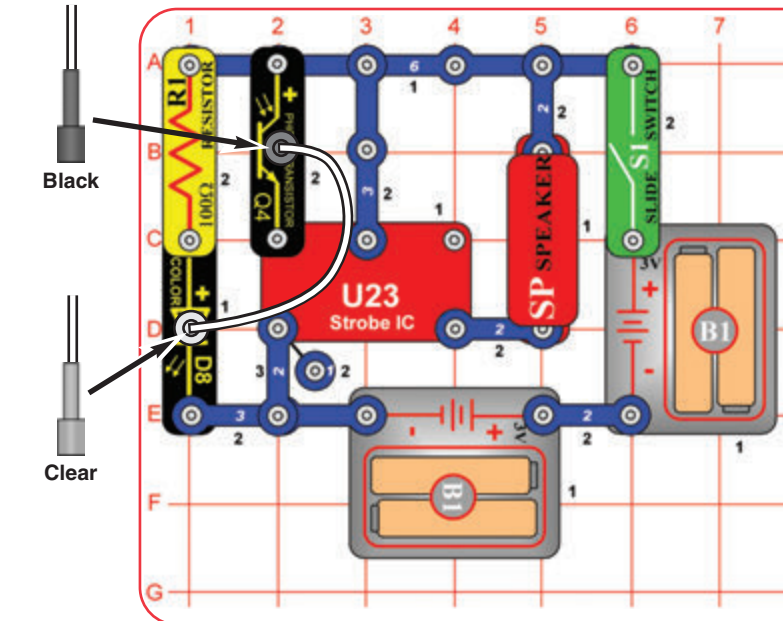

Build the circuit as shown. Place the clear cable holder on the color LED (D8) and the black cable holder on the phototransistor (Q4), then place the fiber optic cable into the holders as far as it will go. For best performance the fiber optic cable should stand straight up in the holders, without bending them.

Turn on the slide switch (S1). Light is transmitted from the color LED, through the fiber optic cable, to control the strobe IC (U23) and speaker (SP).





Project 19

Sound Maker

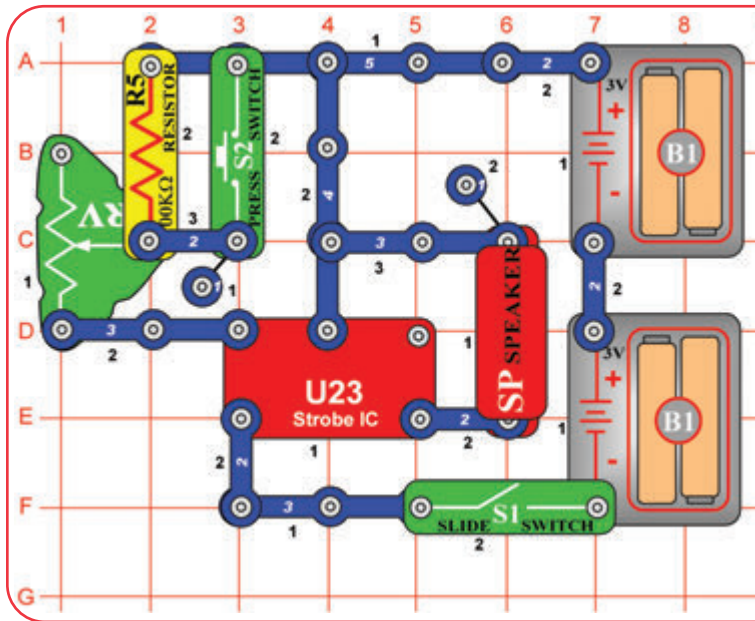

The strobe IC (U23) produces an electrical "tone". The pitch of the "tone" is adjusted by changing how much electricity flows into its upper-left snap, using a resistor. The electrical tone it produces can be used to make sound using a speaker, or to control the flash rate of an LED see project TBD, the Strobe Light).



Build the circuit and turn on the switch (S1). You hear sound from the speaker. Adjust the sound using the lever on the adjustable resistor (RV), and by pushing the press switch (S2).

Note: In rare cases the circuit may not work at all settings on RV. If this happens, move the RV lever to the side near the strobe IC, turn the slide switch off and on to reset the circuit, and only move the RV lever over a small range.



Project 20 Strobe Light

Use the preceding circuit, but replace the speaker with the white LED (D6). Now you have a strobe light!

When S2 is pressed, the light may be blinking so fast that it appears to be on continuously.



Project 21 Color Strobe Light

Use the preceding circuit, but replace the white LED with the color LED (D8).

The color LED will not be changing colors like it does in other circuits. When the strobe IC (U23) turns the color LED on and off, it resets the color-control microcircuit in the color LED. Even your slowest strobe speed is too fast for the color LED.



Project 22 Red Strobe Light

Use the preceding circuit but replace the color LED (D8) with the red LED (D1).

Project 23 Noisy Strobe Light

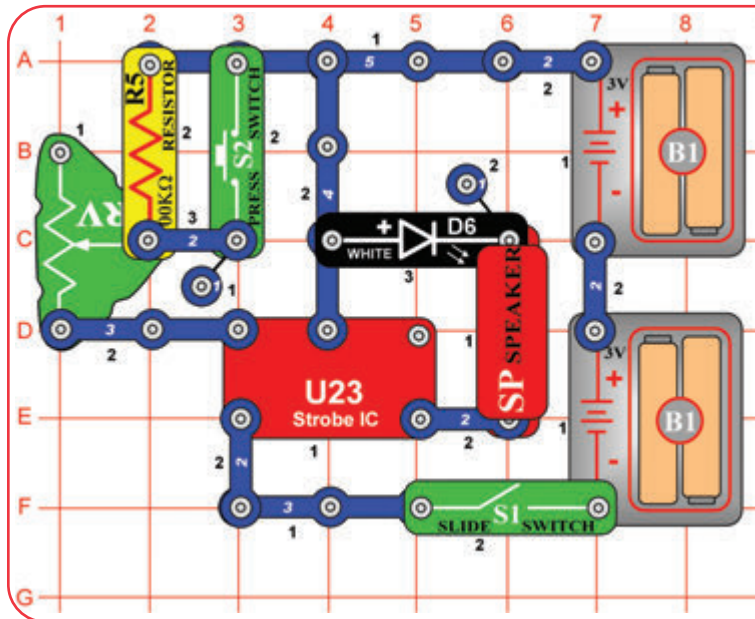

Modify the project 19 circuit to be this one, which has the white LED (D6) next to the speaker (SP). Build the circuit and turn on the switch (S1). Adjust the blink rate and sound using the lever on the adjustable resistor (RV), and by pushing the press switch (S2).

Note: In rare cases the circuit may not work at all settings on RV. If this happens, move the RV lever to the side near the strobe IC, turn the slide switch off and on to reset the circuit, and only move the RV lever over a small range.

Project 24 Noisy Red Strobe Light

Use the preceding circuit but replace the white LED (D6) with the red LED (D1) or the color LED (D8).

Project 25 Double Strobe Light

Use the preceding circuit but replace the speaker and LED with any two LEDs (red, white, or color).

Project 26 Louder Strobe Light

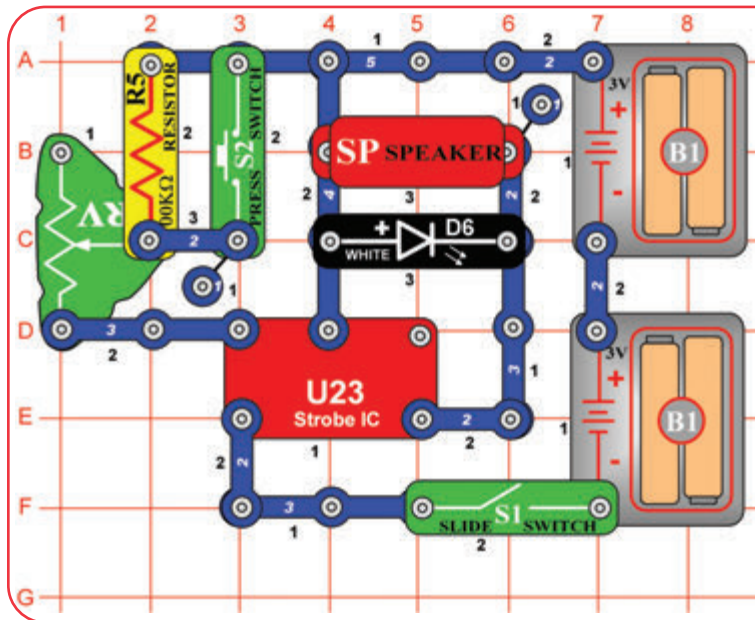

Modify the preceding circuit to be this one, which has the white LED (D6) in parallel with the speaker (SP). Build the circuit and turn on the switch (S1). Adjust the blink rate and sound using the lever on the adjustable resistor (RV), and by pushing the press switch (S2).

This circuit is louder than the previous circuits because the speaker is in parallel with the LED instead of in series with it. This increases the voltage across the speaker, making it louder.



Project 27 Louder Color Strobe Light

Use the preceding circuit but replace the white LED (D6) with the red LED (D1) or the color LED (D8).

Project 28 Triple Strobe Light

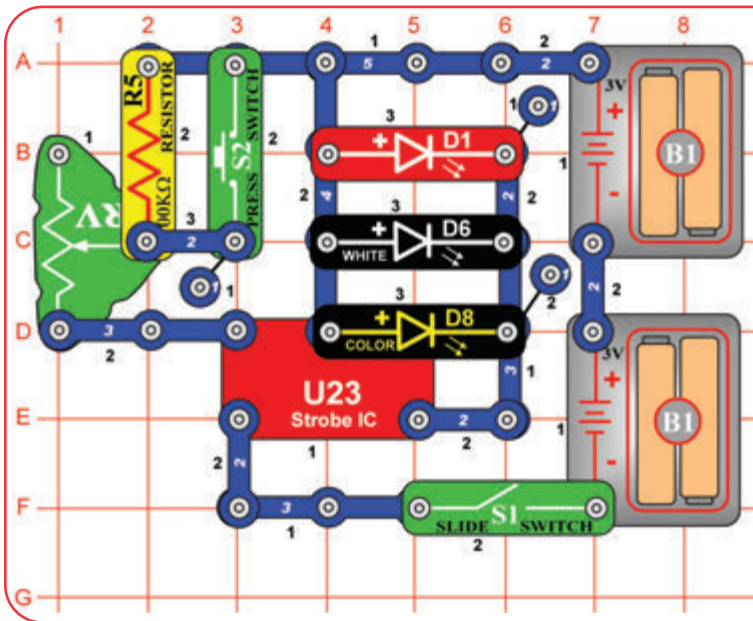

Build this circuit and turn on the slide switch (S1). Adjust the blink rate using the lever on the adjustable resistor (RV), and by pushing the press switch (S2).

Note: In rare cases the circuit may not work at all settings on RV. If this happens, move the RV lever to the side near the strobe IC, turn the slide switch off and on to reset the circuit, and only move the RV lever over a small range.

Project 29 Noisy Double Strobe Light

Use the preceding circuit but replace one of the LEDs (D1, D6, or D8) with the speaker (SP).

Project 30 Noisy Triple Strober

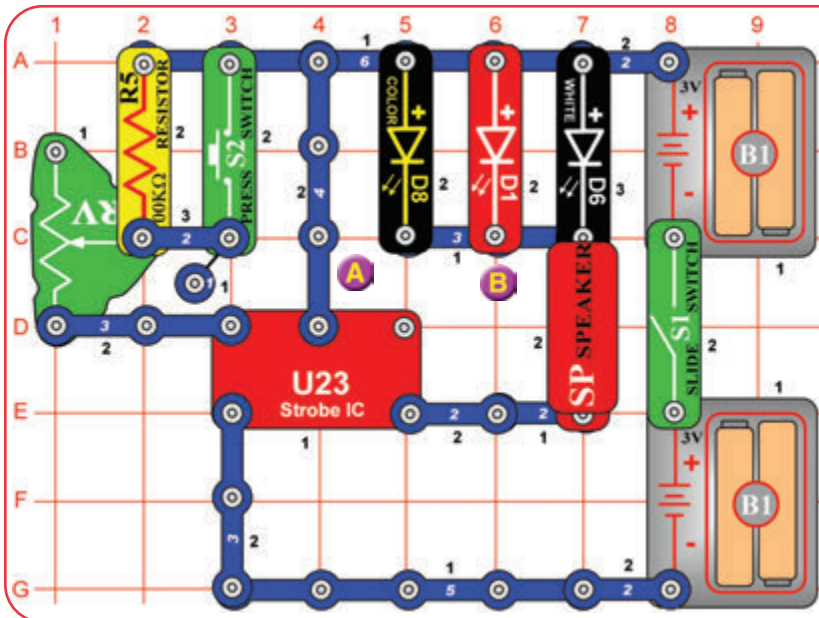

Build this circuit and turn on the slide switch (S1). Adjust the blink rate and sound using the lever on the adjustable resistor (RV), and by pushing the press switch (S2).

Note: In rare cases the circuit may not work at all settings on RV. If this happens, move the RV lever to the side near the strobe IC, turn the slide switch off and on to reset the circuit, and only move the RV lever over a small range.

Project 31 Triple Light Noisy Motion Strober

Use the preceding circuit but replace the speaker (SP) with the motor (M1, "+" toward D6), then place the speaker across the points marked A & B in the drawing. Do not place any fan on the motor.

The LEDs (D1, D6, & D8) flash, the speaker makes noise, and the motor shaft spins or wiggles. Adjust the blink rate, sound, and motor spin using the lever on the adjustable resistor (RV), and by pushing the press switch (S2).

WARNING: Moving parts. Do not touch the fan or motor during operation.



Project 32

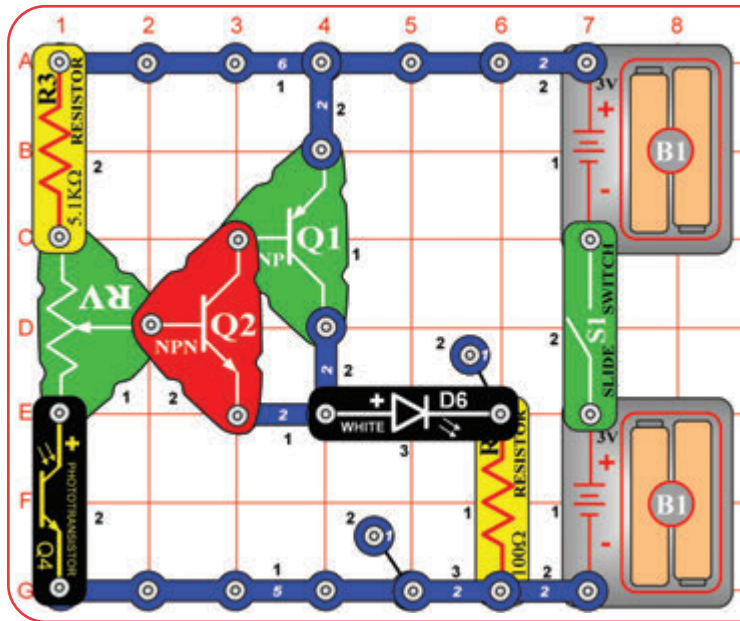

Automatic Light

Build the circuit and turn on the slide switch (S1). Set the lever on the adjustable resistor (RV) so the white LED (D6) just turns off. Slowly cover the phototransistor (Q4) and the white LED brightens. Adjust the light to the phototransistor to turn the white LED on or off.

This is an automatic street lamp that you can turn on at a certain darkness and turn off by a certain brightness. This type of circuit is installed on many outside lights and forces them to turn off and save electricity. They also come on when needed for safety.

You can replace the white LED with the color LED (D8) or the red LED (D1), but you may need to readjust the sensitivity using the lever on RV.



Project 33

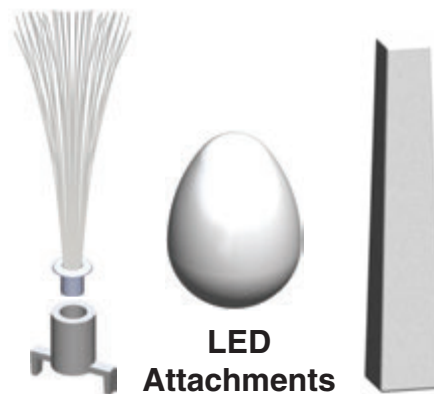
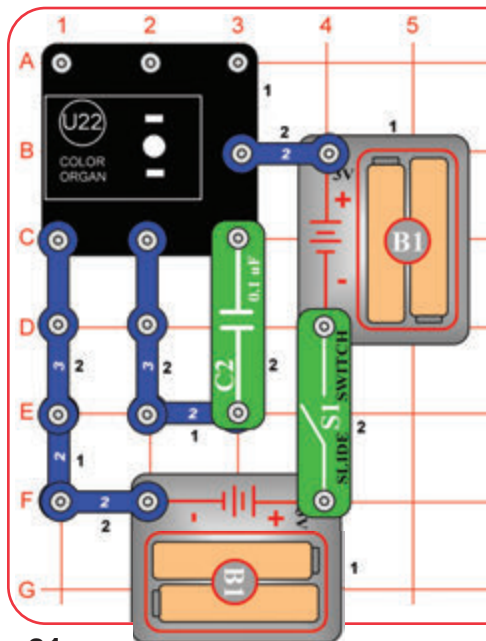

This circuit is an oscillator; it uses the color organ to control itself.



Build the circuit as shown, and place one of the LED attachments (tower, egg, or fiber optic tree) over the LED on the Color Organ (U22). Turn on the switch (S1) and watch. The color organ light will change colors on its own.



Project 34

Dance to the Music

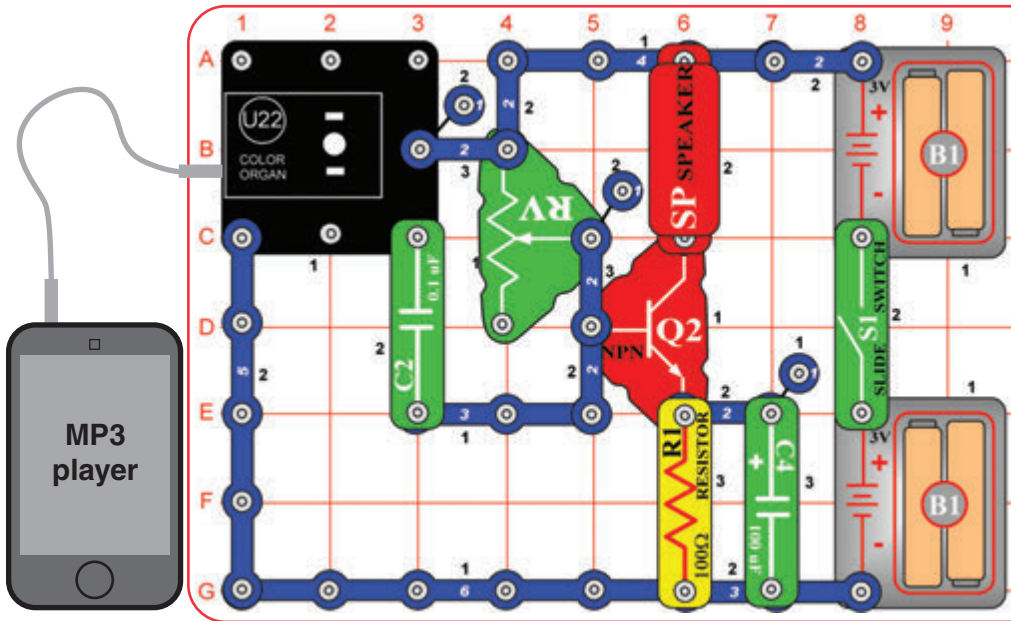

This circuit amplifies the music so it can be heard on the speaker. This is a simple circuit, so sound quality may not be as good as your other music players.



Build the circuit. Connect a music device (not included) to the color organ (U22) as shown, and start music on it. Place one of the LED attachments over the light on the color organ. Set the lever on the adjustable resistor (RV), and the volume control on your music device, for best sound quality and light effects. The color organ light will “dance” in synchrony with the music. Compare fast and slow songs, and different loudness levels.

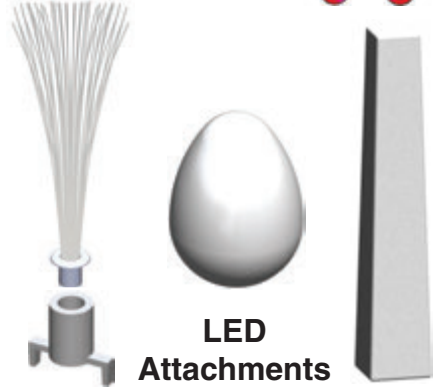

Project 35 Super Dance to the Music

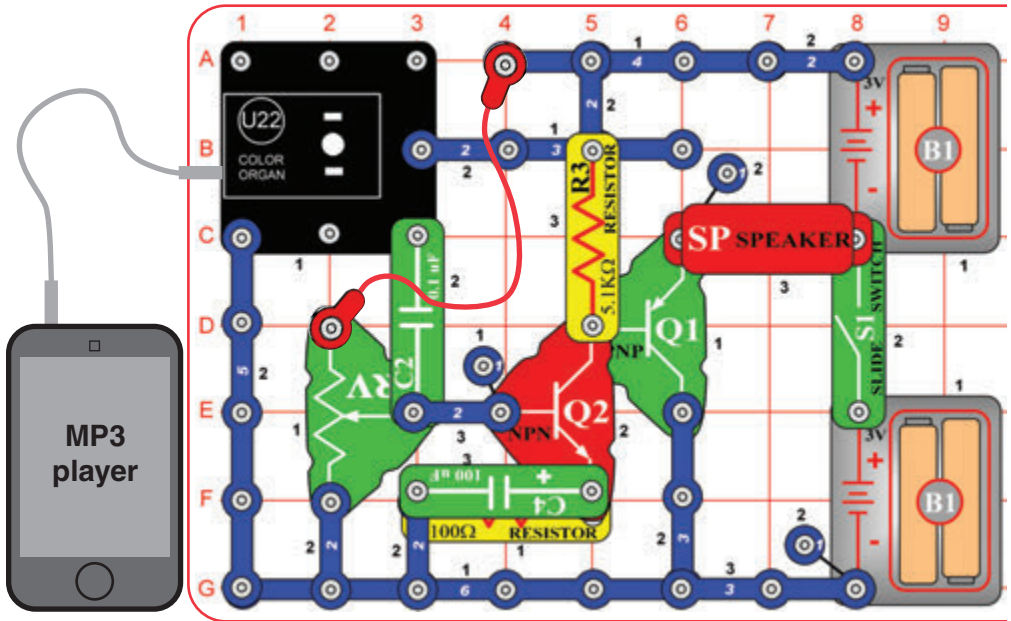

This circuit is similar to the preceding one, but louder and more sensitive. Build the circuit as shown. Connect a music device (not included) to the color organ (U22) as shown, and start music on it, set the volume to mid-range. Place one of the LED attachments over the light on the color organ. Turn on the switch (S1) and SLOWLY ADJUST the lever on the adjustable resistor (RV) for best sound; there will only be a narrow range where the sound is clear. Adjust the volume on your music device for best sound quality.

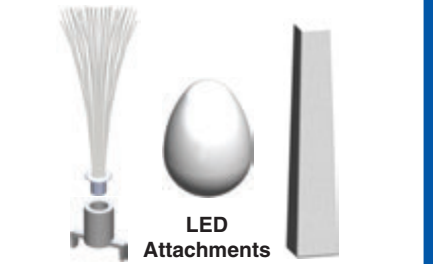

Project 36 Super Dance to the Music (II)

Use the preceding circuit, but remove the 100µF capacitor (C4). The sound will not be as loud, but will be less distorted. Adjust RV and the volume on your music device for best sound.



Project 37

Follow the Music

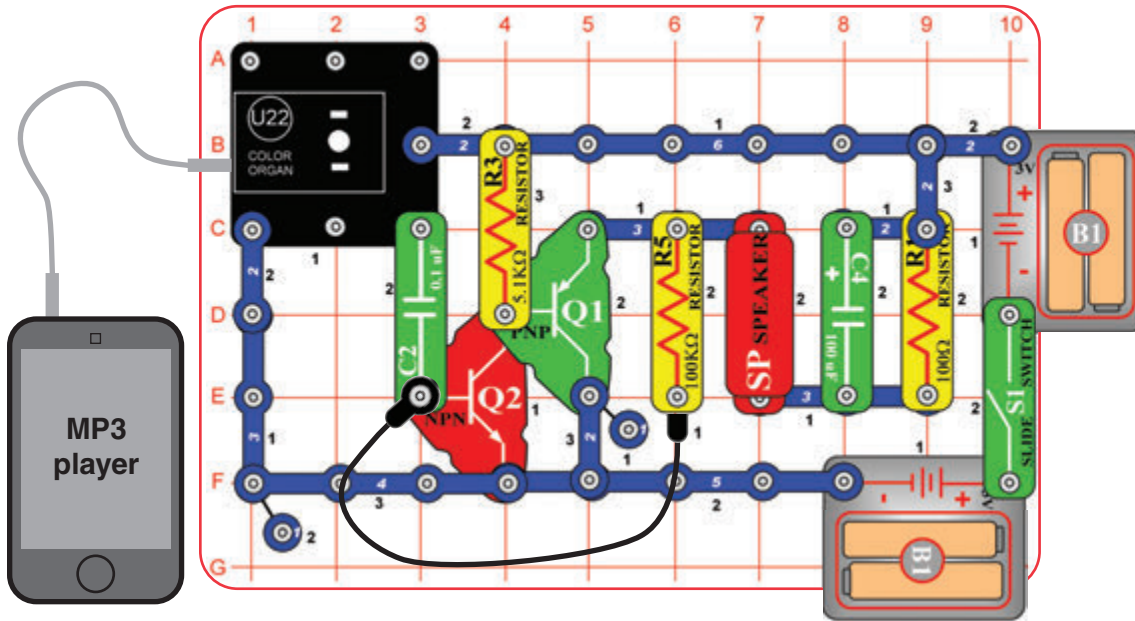

Build the circuit. Connect a music device (not included) to the color organ (U22) as shown, and start music on it. For best effects, place one of the LED attachments over the light on the color organ. Set the volume control on your music device for best sound quality and light effects. The color organ light will “dance” in synch with the music. Compare fast and slow songs, and different loudness levels.

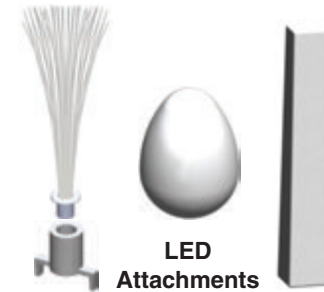

Project 38

Color Organ - Headphones

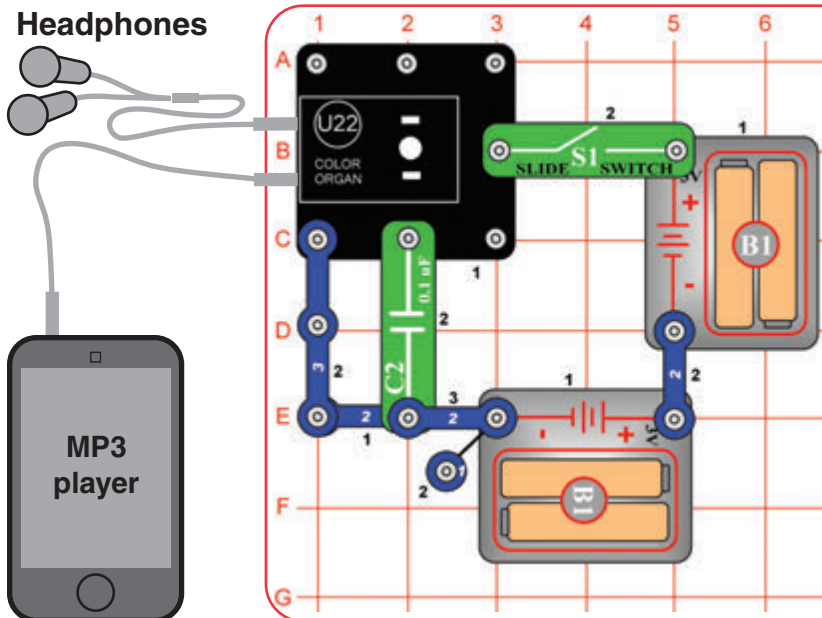

Compare the sound quality of using headphones in this circuit, to using the speaker in the preceding circuit.



Build the circuit. Connect a music device (not included) and your own headphones (not included) to the color organ (U22) as shown, and start music on it. For best effects, place one of the LED attachments over the light on the color organ. Set the volume control on your music device for best sound quality and light effects. The color organ light will “dance” in synch with the music.



Project 39

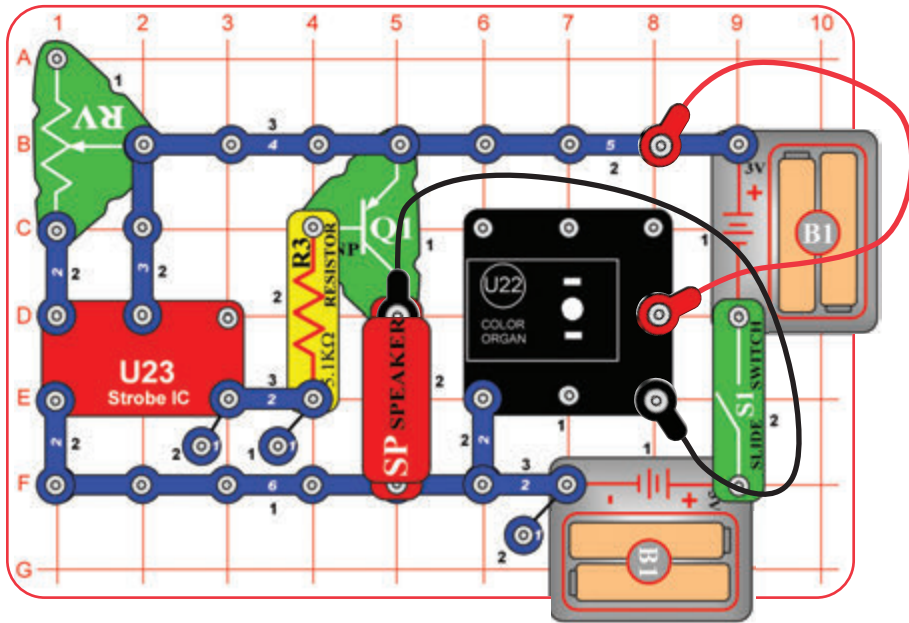

Adjustable Light Dance

Build the circuit as shown. For best effects, place one of the LED attachments over the light on the color organ. Turn on the switch (S1) and move the lever on the adjustable resistor (RV) to change the tone of the sound and “speed” of the light.

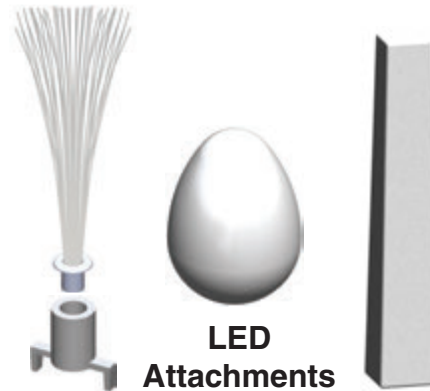

Project 40

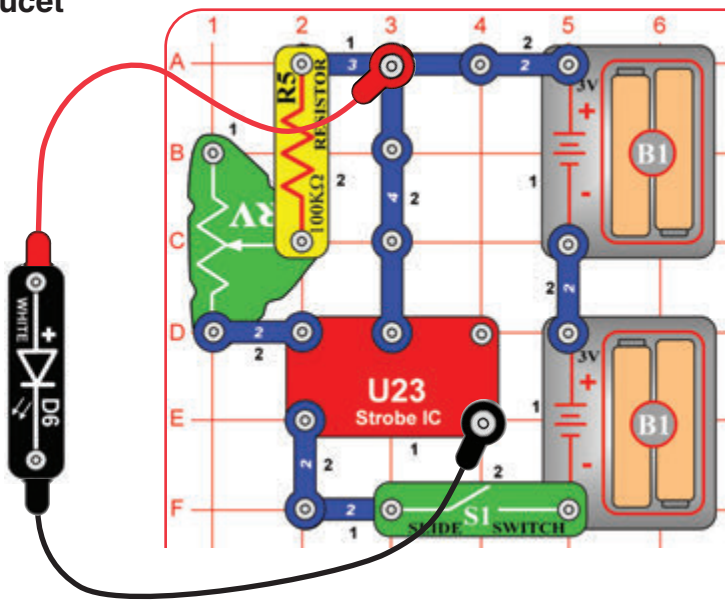
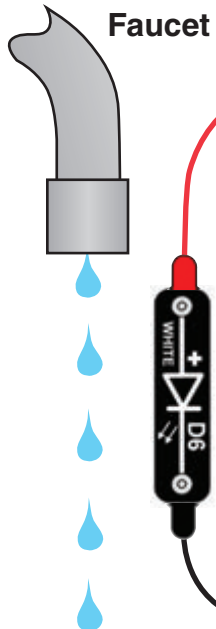

Suspended Raindrops

Build the circuit as shown. Connect the white LED (D6) to the red & black jumper wires. Turn on the slide switch (S1). Go to a water faucet and adjust the faucet so water is dripping at a steady rate. Dim the room lights and hold the white LED so it shines on the dripping water. Try to set the lever on the adjustable resistor (RV) so that the dripping water drops appear suspended in mid-air. You may need to adjust the drip rate on the faucet to make this work. You may get better results if you replace the 100kΩ resistor (R5) with the 5.1kΩ resistor (R3). Also, try setting the strobe rate to minimum and adjusting the drip rate.



Project 41 Infrared Detector

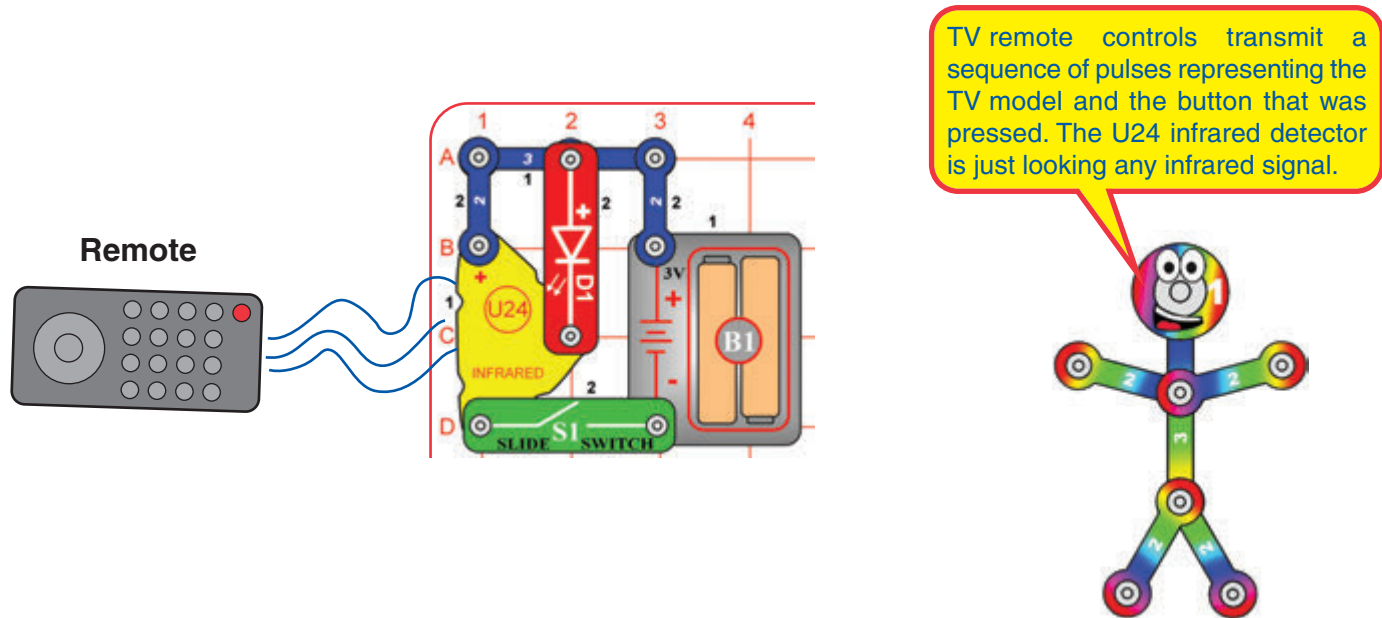

You need an infrared remote control for this project, such as any TV/stereo/DVD remote control in your home.

Build the circuit and turn on the switch (S1). Point your remote control toward the infrared module (U24) and press any button to activate the red LED (D1).



Project 42 Audio Infrared Detector

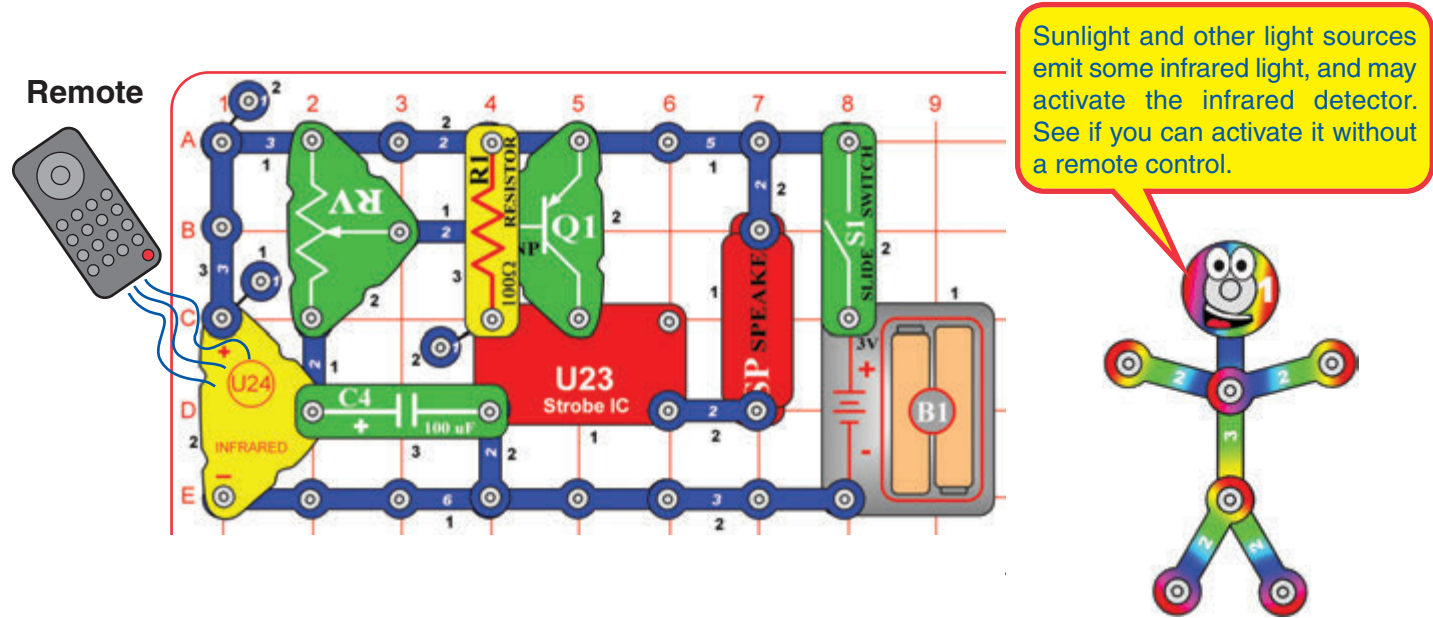

You need an infrared remote control for this project, such as any TV/stereo/DVD remote control in your home.

Build the circuit and turn on the switch (S1). Point your remote control toward the infrared module (U24) and press any button to activate an alarm sound. The lever on the adjustable resistor (RV) sets the how long the alarm plays for.



Project 43

Photo Infrared Detector

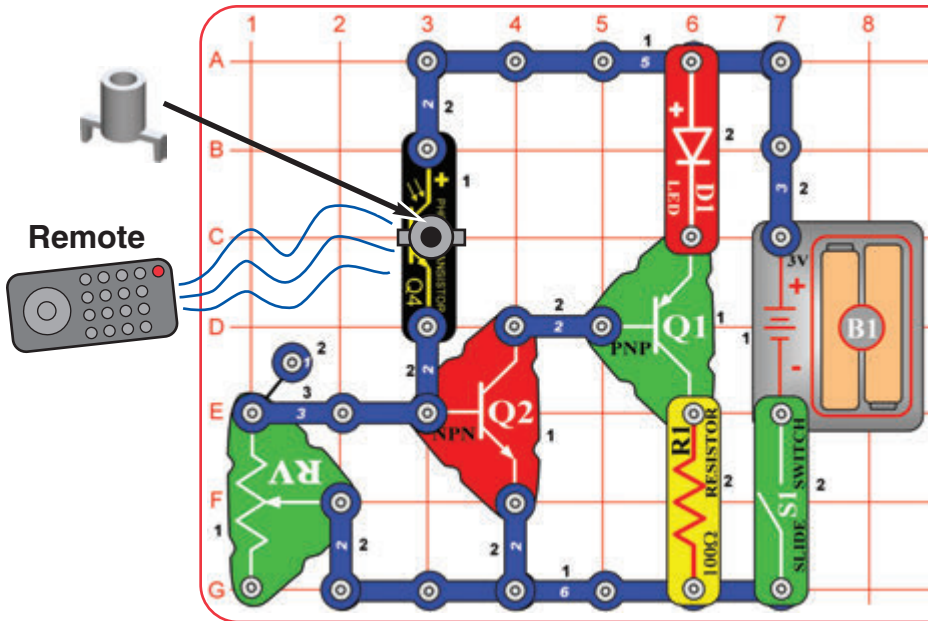

The phototransistor can detect light, and infrared light is light. The infrared module (U24) is designed to focus only on infrared light.



You need an infrared remote control for this project, such as any TV/stereo/DVD remote control in your home.

Build the circuit and turn on the switch (S1). Place the mounting base (normally used with the fiber optic tree) on the phototransistor (Q4). Set the lever on the adjustable resistor (RV) so the red LED (D1) just turns off; if it never turns off, move away from room lights. Point your remote control directly into the mounting base on Q4, and press any button to activate the red LED (D1).



Project 44 Photo Audio Infrared Detector

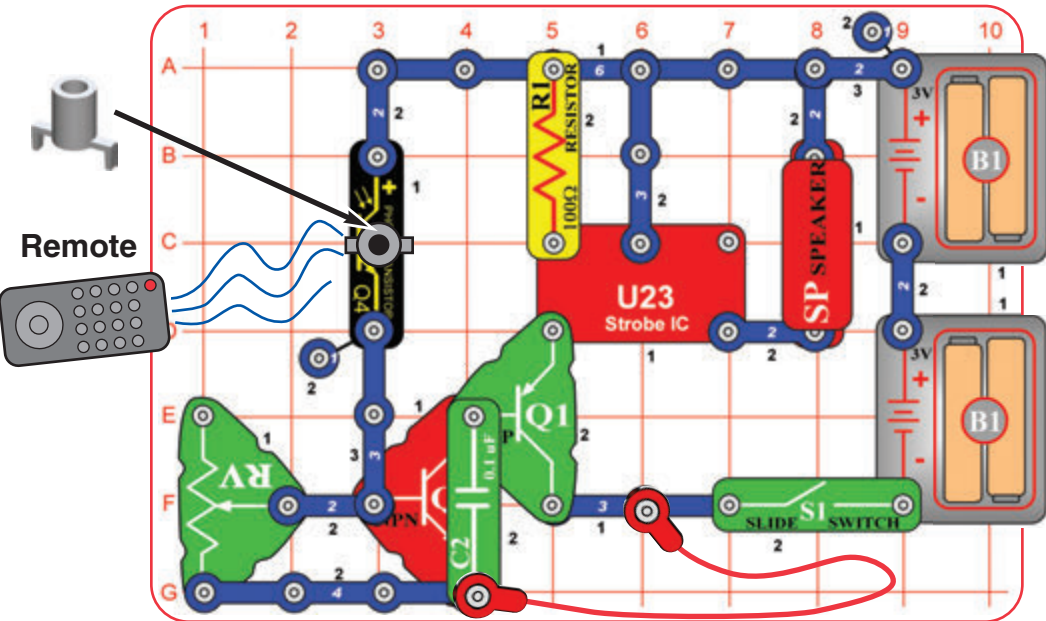

You need an infrared remote control for this project, such as any TV/stereo/DVD remote control in your home.

Build the circuit and turn on the switch (S1). Place the mounting base (normally used with the fiber optic tree) on the phototransistor (Q4). Set the lever on the adjustable resistor (RV) so the sound just turns off (if it never turns off, move away from room lights). Point your remote control directly into the mounting base on Q4, and press any button to activate the sound.



Project 45 Photo Audio Infrared Detector (II)

Use the preceding circuit, but replace the 0.1µF capacitor (C2) with the 100µF capacitor (C4). The circuit works the same way, but the sound stays on longer and is more pleasant.



Project 46

Strobe Effects

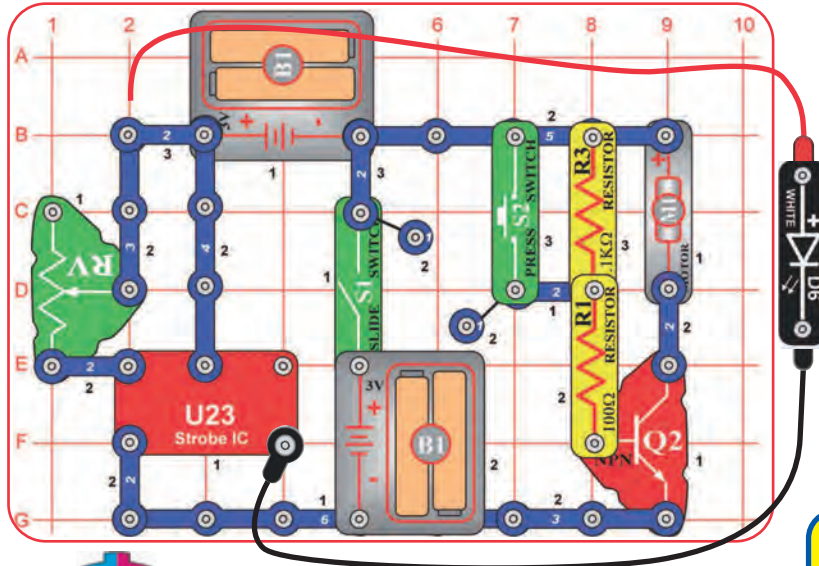

Build the circuit as shown. Take the colored disc shown and install it into the disc holder, then place the disc holder on the motor (M1). Connect the white LED (D6) to the red & black jumper wires.

For best effects, do this in a dimly lit room. Turn on the slide switch (S1). Push the press switch (S2) until the motor spins continuously (if it stops after you release the press switch, replace your batteries). Hold the white LED upside down over the disc holder so it shines on the spinning disc, and move the lever on the adjustable resistor (RV) slowly while watching the pattern on the spinning disc.

The motor spins the disc so fast that it looks like a blur. However, as you slowly adjust RV the pattern on the disc appears to slow down, stop, and reverse direction. Patterns close to the disc center may be moving at different speeds, or in different directions, from patterns farther from the center! Some patterns may become clear while others are still blurred.

If the motor does not continue spinning after you release S2, then replace your batteries. If it still won't keep spinning then replace the 5.1kΩ resistor (R3) with the 100Ω resistor (R1).

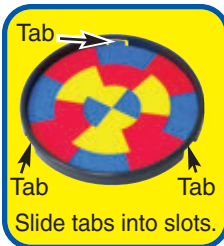
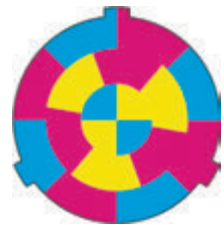

How does this work? The strobe IC is making the white LED flash so fast that your eyes think it is on continuously. RV sets the flash rate, and at some settings the LED flashes are synchronized with speed of the patterns spinning on the disc, making them appear visible instead of blurred.

When the disc pattern is totally blurred, it will appear as purple, orange, and light green. Combining equal amounts of red & blue makes purple, red & yellow makes orange, and yellow & blue makes green.

OPTIONAL (Adult supervision required)

The disc holder rests on the motor top loosely and vibrates, making the disc pattern blurry even when the RV setting makes the pattern "stop". The disc patterns will appear clearer if you permanently mount the disc holder to the motor top. This set contains a spare motor top, which can be used for this. This requires removing the motor top from the motor whenever you want to switch from using the disc holder to using the glow fan, so is optional, and requires adult supervision.

If you want to do this, pry the motor top off the motor shaft using a screwdriver.



Lay the spare motor top in the disc holder upside down, and bond together with glue (glue not included).

After the glue dries, push the modified disc holder on the motor shaft and install a disc cutout. When you want to return to using the glow fan, replace the motor top disc holder with the normal motor top.



Project 47 Slow Strobe Effects

Use the preceding circuit, but replace the 3-snap on the adjustable resistor (RV) with the 100kΩ resistor (R5). The circuit works the same, but the strobe rate is much slower (now you can see the LED flashing), so the strobe effects are different. Slowly adjust the setting on RV as before, and watch the patterns on the spinning disc.

Note: In rare cases the LED may not flash at all settings on RV. If this happens, move the RV lever to the side near the strobe IC, turn the slide switch off and on to reset the circuit, and only move the RV lever over a small range.

Bonus for owners of other Boffin sets: If you have a second 100kΩ resistor (from model SC-100 / 300 / 500 / 750 or other sets), place it directly over the R5 that replaced the 3-snap in the above circuit (and place a 1-snap under one side of the additional R5). Stacking the two 100kΩ resistors together creates a "medium" range of strobe speeds, in between the speeds created with the 3-snap and single 100kΩ. Adjust the RV setting and watch the strobe effects as before.

Project 48 Stable Strobe Effects

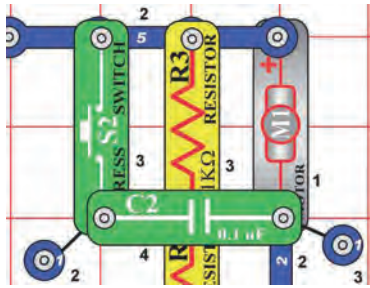

The 0.1μF capacitor has no electrical effect, but it helps to hold the motor in place better and reduce vibrations. Less motor vibration makes the disc holder more stable, and so makes the patterns a little clearer. See if you can notice a difference.



Use the circuits from projects 46 and 47, but add the 0.1μF capacitor (C2) next to the motor, as shown here. Set the strobe speed so the patterns are visible, and see if they look less blurred than before.

Project 49 Strobe Effects (II)



When the disc pattern is totally blurred, it appears to be white. Combining equal amounts of red, green, and blue makes white. The LED in the color organ IC combines red, green, and blue lights to make white.



Replace the disc in the disc holder with the one shown here, and repeat projects 46-48. Observe the strobe effects. To remove a disc from the holder, use your fingernail, or use a pencil to push it up from beneath one of the tabs.

Project 50 Strobe Effects (III)



Replace the disc in the disc holder with the one shown here, and repeat projects 46-48. Observe the strobe effects. At some RV settings, the rainbow of colors comes into view.

Project 51 Strobe Effects (IV)



Replace the disc in the disc holder with the one shown here, and repeat projects 46-48. Observe the strobe effects. With this pattern, some areas may appear to be moving at different speeds or directions. Sometimes you can see all the colors on the disc, but sometimes you can see all the colors except blue, which is hidden.

Project 52 Strobe Effects (V)



Replace the disc in the disc holder with the one shown here, and repeat projects 46-48. Observe the strobe effects. This unusual pattern produces several amazing displays at different RV settings.



Project 53 Strobe Effects (VI)

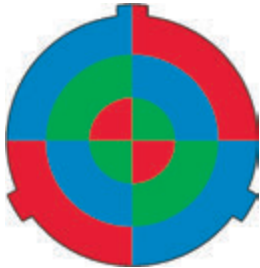

Replace the disc in the disc holder with the one shown here, and repeat projects 46-48. Observe the strobe effects. When the disc pattern is totally blurred, it will appear as purple, cyan, and yellow. Combining equal amounts of red & blue makes purple, green & blue makes cyan, and red & green makes yellow.



Project 54 Make Your Own Strobe Effects

Draw your own patterns on paper or cardboard, then cut them to the same size as our discs. You can also draw patterns on the backs of our discs. Put them on the disc holder and repeat projects 46-48. Have a contest with your friends to see who can make the most interesting strobe effects! You can also find lots of fun patterns and visual illusions by doing a search on the internet. There is no limit to what you can do!



Project 55

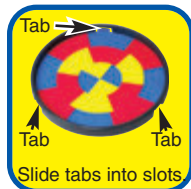
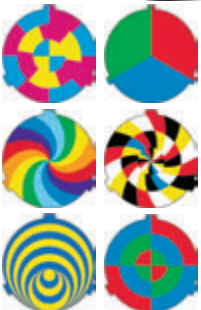
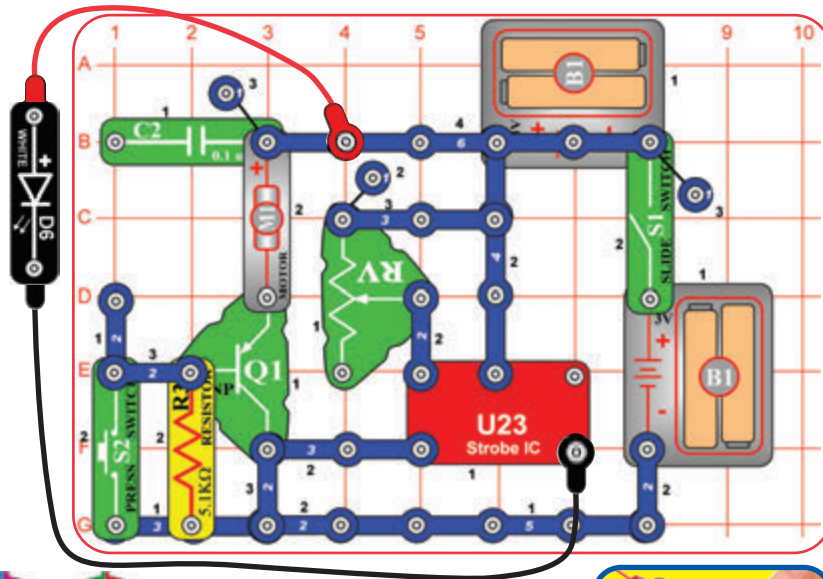

Another Strobe Light

This circuit is similar to project 46, and works the same way. Build the circuit as shown. Take one of the colored discs and install it into the disc holder, then place the disc holder on the motor (M1). Connect the white LED (D6) to the red & black jumper wires.

For best effects, do this in a dimly lit room. Turn on the slide switch (S1). Push the press switch (S2) until the motor spins continuously (if it stops after you release the press switch, replace your batteries). Hold the white LED upside down over the disc holder so it shines on the spinning disc, and move the lever on the adjustable resistor (RV) slowly while watching the pattern on the spinning disc.

The motor spins the disc so fast that it looks like a blur. However, as you slowly adjust RV the pattern on the disc appears to slow down, stop, and reverse direction. Patterns close to the disc center may be moving at different speeds, or in different directions, from patterns farther from the center!

If the motor does not continue spinning after you release S2, then replace your batteries. If it still won't keep spinning then replace the 5.1kΩ resistor (R3) with the 100Ω resistor (R1).

You can reduce the strobe speed by replacing the 3-snap on the adjustable resistor (RV) with the 100kΩ resistor (R5), just as is done in project 48.



Project 56

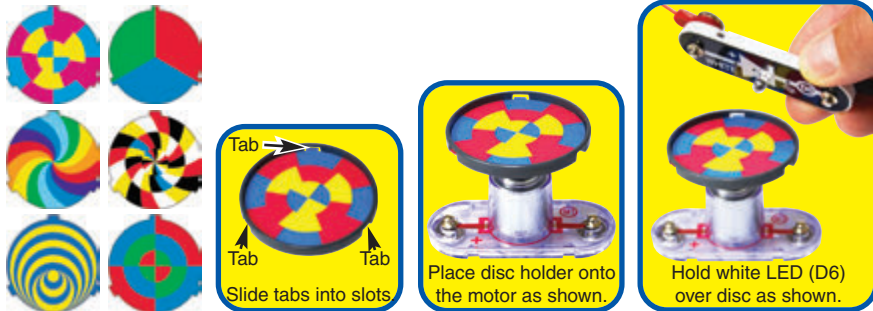
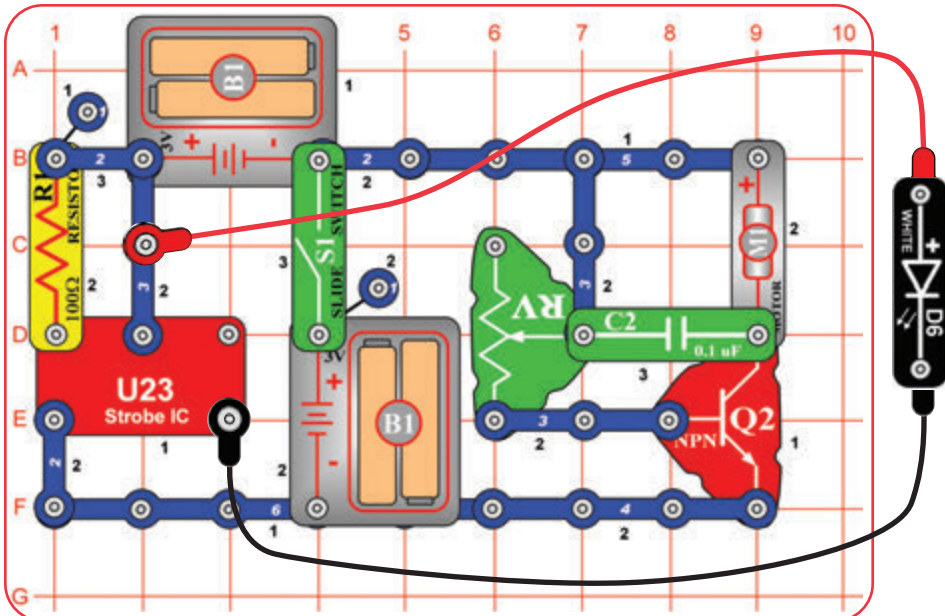

Motor Strobe Effects

This project is similar to project 46. Build the circuit as shown. Take one of the colored discs and install it into the disc holder, then place the disc holder on the motor (M1). Connect the white LED (D6) to the red & black jumper wires.

For best effects, do this in a dimly lit room. Turn on the slide switch (S1). Set the lever on the adjustable resistor (RV) down towards the 4-snap. Hold the white LED upside down over the disc holder so it shines on the spinning disc, and move the lever on the adjustable resistor (RV) slowly while watching the pattern on the spinning disc.

The motor spins the disc so fast that it looks like a blur. However, as you slowly adjust RV the pattern on the disc appears to slow down, stop, and reverse direction. Patterns close to the disc center may be moving at different speeds, or in different directions, from patterns farther from the center!

Compare this circuit to the one in project 47. This project changes the strobe effects by using RV to control the motor speed, while project 47 does it by using RV to control the LED flash rate. Getting the best strobe effects by adjusting the motor speed is more difficult, because the motor takes time to adjust its speed, while the LED flash rate adjusts instantly.



Project 57

Motor Strobe Effects (II)

Use the preceding circuit, but replace the 100Ω resistor (R1) with the 5.1kΩ resistor (R3). The circuit works the same, but the LED flash rate is slower, so the strobe effects are different. Adjust the setting on RV as before, and watch the patterns on the spinning discs.



Project 58

Motor Strobe Effects (III)

Use the preceding circuit, but replace the 5.1kΩ resistor (R3) with the 100kΩ resistor (R5). The circuit works the same, but the LED flash rate is slower (now you can see the LED flashing), so the strobe effects are different. Adjust the setting on RV as before, and watch the patterns on the spinning discs.



Project 59

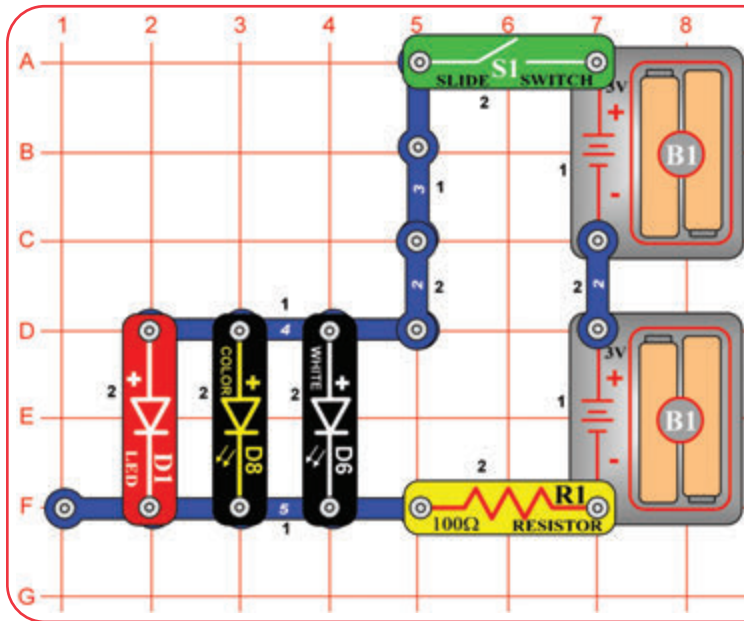

LEDs Together

Turn on the slide switch (S1), and compare the brightness of the three LEDs.

Next, remove any of the LEDs and see how the brightness of the others changes.

The voltage needed for an LED to turn on depends on the light color. Red light needs the least, green needs more, but blue and white need the most. The color LED (D8) contains red, green, and blue LEDs.

The R1 resistor reduces the voltage available to the LEDs. The LED brightness varies because some of the LEDs need more voltage than is available. The red LED (D1) will dominate the other colors because it turns on more easily.



Project 60

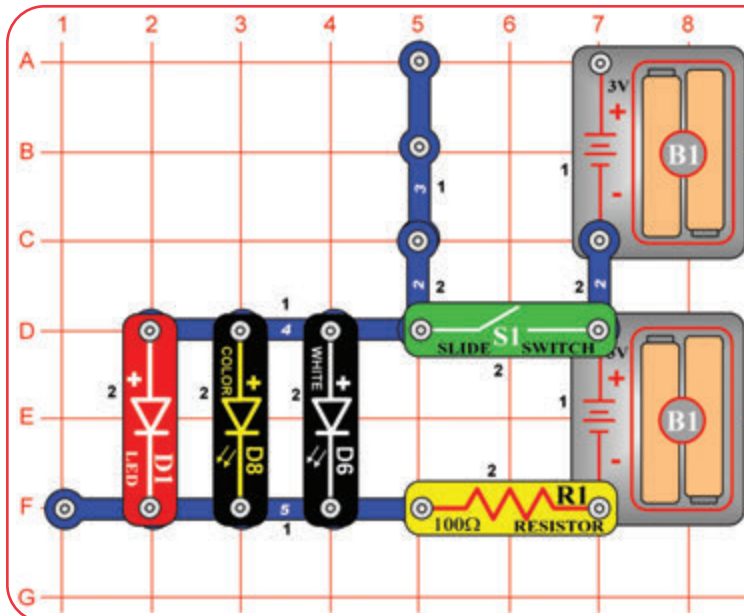

LEDs Together (II)

Modify the preceding circuit by moving the slide switch (S1) to the location shown here. Compare the brightness of the LEDs. Some LEDs may not turn on.

Next, remove any of the LEDs and see how the brightness of the others changes.

This circuit reduces the voltage to the circuit, because only one set of batteries is connected. The limited battery voltage is split between the R1 resistor and the LEDs. The remaining voltage across the LEDs is enough to activate the red LEDs, but may not be enough to activate the other colors. With the reduced voltage, the red LED will dominate even more than in the preceding circuit.





Project 61

Brightness Control

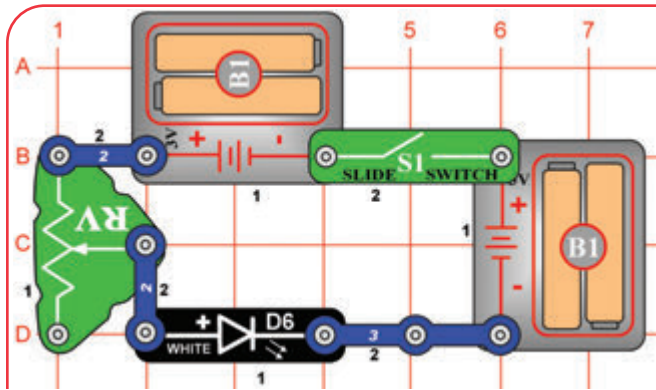

Build the circuit and turn on the slide switch (S1). Move the lever on the adjustable resistor (RV) to vary the brightness of the light from the white LED (D6). If desired, you may place any of the LED attachments (tower, egg, or fiber optic tree) on the LED.

Resistors are used to control or limit the flow of electricity in a circuit. Higher resistor values reduce the flow of electricity in a circuit.

In this circuit, the adjustable resistor is used to adjust the LED brightness, to limit the current so the batteries last longer, and to protect the LED from being damaged by the batteries.

What is Resistance? Take your hands and rub them together very fast. Your hands should feel warm. The friction between your hands converts your effort into heat. Resistance is the electrical friction between an electric current and the material it is flowing through.

The adjustable resistor can be set for as low as 200 Ω , or as high as



Project 62

Resistors

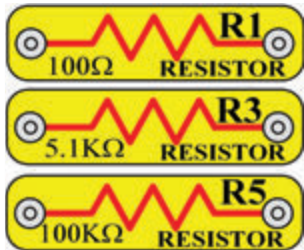

Use the circuit built in project 61, but replace the 3-snap with one of the yellow resistors in this set (R1, R3, or R5). Observe how each changes the LED brightness at different settings for the adjustable resistor.

The R1 resistor (100 Ω) will have little effect, since it will be dominated by the adjustable resistor. Resistor R5 (100k Ω) is a high resistance, which greatly restricts the flow of electricity, so the LED will be very dim or off. Resistor R3 (5.1k Ω) will be in between those.



Project 63

Resistors & LEDs

Use the circuits from projects 61 and 62, but replace the white LED (D6) with the red LED (D1) or color LED (D8). Vary the adjustable resistor lever and change the yellow resistors to see how the light varies with each LED.



Project 64 Low Power Brightness Control

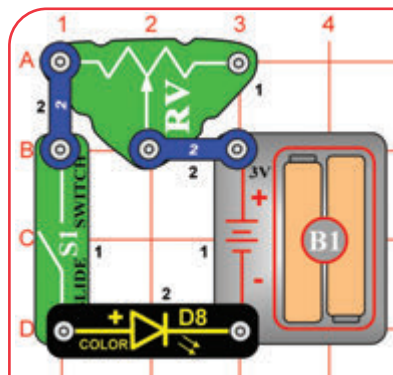

Build the circuit and turn on the slide switch (S1). Move the lever on the adjustable resistor (RV) to vary the brightness of the light from the color LED (D8). For best effects, do this in a dimly lit room. At some RV settings the LED will be very dim, and some of its colors may be totally off.

Project 65 Low Power Resistors & LEDs

Use the circuit from project 64, but replace the color LED (D8) with the red LED (D1) or white LED (D6). Vary the adjustable resistor lever to see how the light varies with each LED. The white LED may not be on at all.

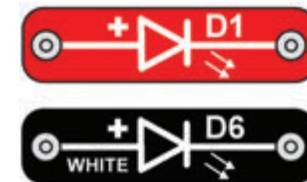

Project 66 Persistence of Vision

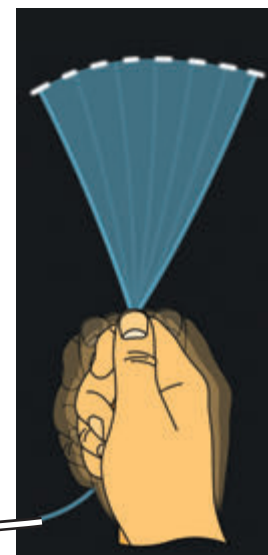
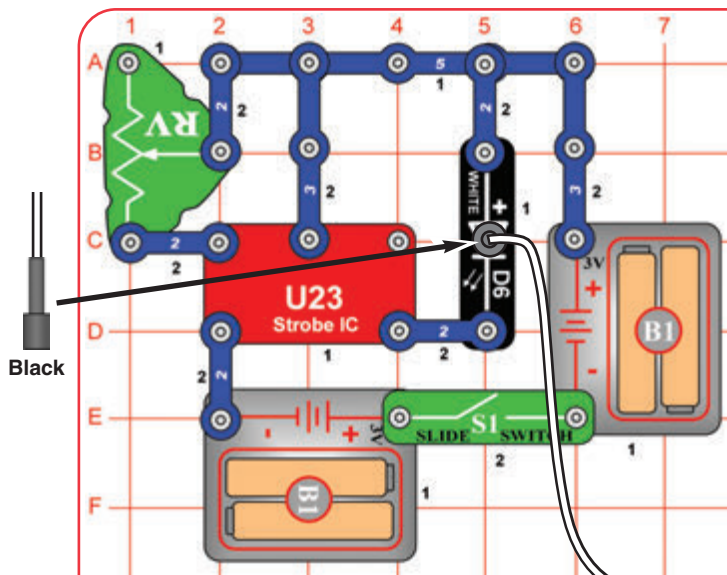

Build the circuit as shown. Place the black fiber optic cable holder on the white LED (D6) and insert the fiber cable into the black holder as far as it will go. Turn on the slide switch (S1). Take the circuit into a dark room and wave the cable around while watching the loose end. Try it with the lever on the adjustable resistor (RV) at different settings. The light coming out the loose end of the fiber optic cable will separate into short segments or dashes of light.

"Persistence of Vision" works because the light is changing faster than your eyes can adjust. Your eyes continue seeing what they have just seen.

In a movie theater, film frames are flashed on the screen at a fast rate (usually 24 per second). A timing mechanism makes a light bulb flash just as the center of the frame is passing in front of it. Your eyes see this fast series of flashes as a continuous movie.

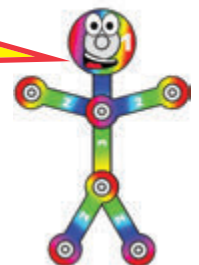

Project 67

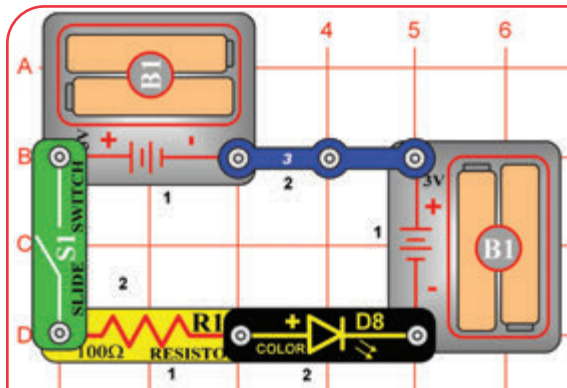

Prismatic Film

This is the same circuit as project 1, but you will view it differently. Turn on the switch (S1), and view the LED through the prismatic film (the clear slide). Prismatic film makes interesting light effects.

Replace the color LED (D8) with the white LED (D6) and red LED (D1); view them through the prismatic film.

Prismatic film separates light into different colors. White light is a combination of all colors.



Project 68 Look at the Lights

View different light sources in and around your home through the prismatic film.

Project 69 Scattering Light

Use the project 67 circuit, but view the color LED through various semi-transparent liquids, glassware, and plastics. Juices, jello, and cloudy glass or plastic work well.

Replace the color LED with the white LED (D6). The white LED is brighter, but does not change color.

Semi-transparent materials scatter the light without completely blocking it, so a wide area of the liquid or material is lit up by the light. This happens in the egg and tower LED attachments.



Project 70 Color Fiber Light

Use the circuit from project 67, but place the clear cable holder on the color LED (D8), then place the fiber optic cable into the holder as far as it will go. Turn on the switch, then take the circuit into a dimly lit room and see the light coming out the open end of the cable. The light travels through the cable even as you bend it around.



Project 71

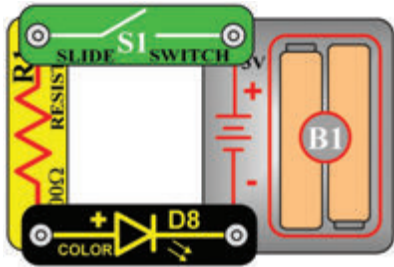

Side view of base grid

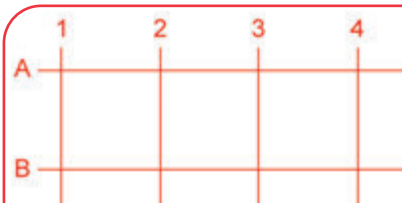

One Way Plastic

Build the circuit shown, but build it without using the base grid. Turn on the switch (S1) and view the color LED (D8) light through the base grid. Then turn the base grid on its side and try to see through it; you can't. Try viewing other lights through other clear materials.

The main surface of the base grid is flat and smooth, giving a nice transition for light rays to pass through. If you look closely at the side edges (using a magnifying glass helps), you will see they are slightly curved. These curves, and the angle of the light hitting them, cause more light to be scattered or reflected than light hitting the main surface. Some materials can also pass light better in some directions than in other directions, due to their physical structure.



Project 72

White Blinker

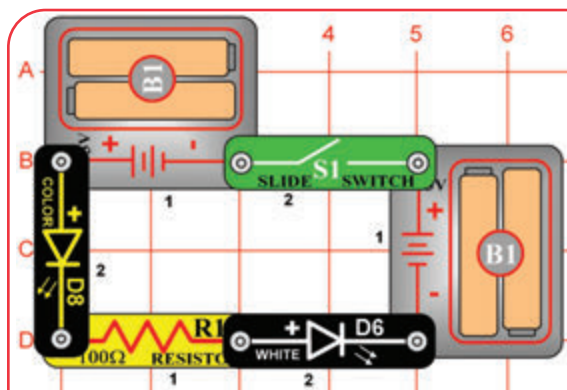

Build the circuit as shown and turn on the switch (S1). Both LEDs are blinking.

The color LED (D8) has a microcircuit that changes the light colors. As it does this, it changes the current through the circuit - which also affects the brightness of the white LED (D6).



Project 73

Red Blinker

Use the preceding circuit, but replace the white LED (D6) with the red LED (D1).



Project 74

Red & White

Use the preceding circuit, but replace the color LED (D8) with the white LED (D6). Both LEDs light, but neither in blinking.

Project 75 Color Selector - Red

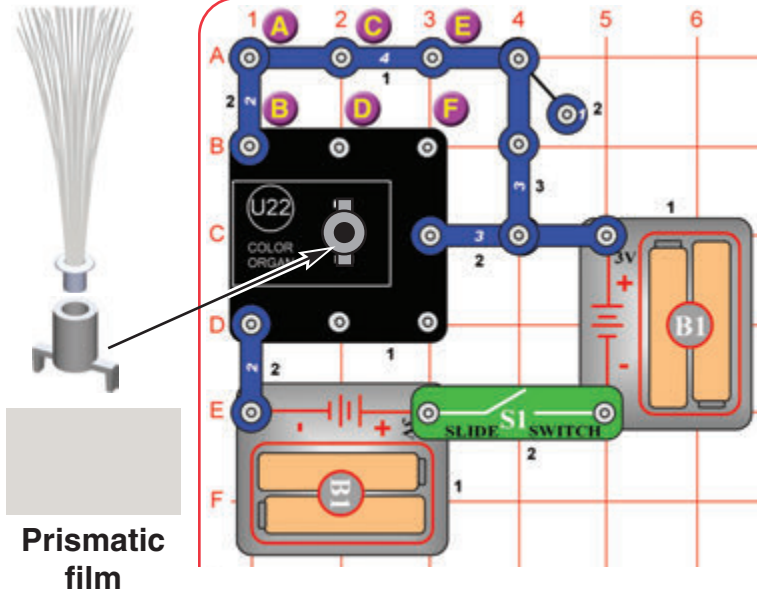

Build the circuit as shown. Place the fiber optic tree and mounting base on the color organ (U22). Turn on the switch (S1). The color organ makes a red light. Remove the fiber optic tree and mounting base, and look at the light through the prismatic film.

Project 76 Color Selector - Green

Use the preceding circuit, but remove the 2-snap between points A & B, and add one between points C & D. Now the color is green. Look at it using the fiber optic tree, and then the prismatic film.

Project 77 Color Selector - Blue

Use the preceding circuit, but remove the 2-snap between points C & D, and add one between points E & F. Now the color is blue. Look at it using the fiber optic tree, and then the prismatic film.

Project 78 Color Selector - Cyan

Use the preceding circuit, but add a 2-snap between points C & D. Now the color is cyan, which is a combination of green and blue. Look at it using the fiber optic tree, and then the prismatic film.

Project 81 Color Selector - White

Use the preceding circuit, but add a 2-snap between points C & D. Now the color is white, which is a combination of red, green, and blue. Look at it using the fiber optic tree, and then the prismatic film.

Project 79 Color Selector - Yellow

Use the preceding circuit, but remove the 2-snap between points E & F, and add one between points A & B. Now the color is yellow, which is a combination of red and green. Look at it using the fiber optic tree, and then the prismatic film.

Project 80 Color Selector - Purple

Use the preceding circuit, but remove the 2-snap between points C & D, and add one between points E & F. Now the color is purple, which is a combination of red and blue. Look at it using the fiber optic tree, and then the prismatic film.

Black is made by turning off all the colors.

Project 82 LED Color Spectrum

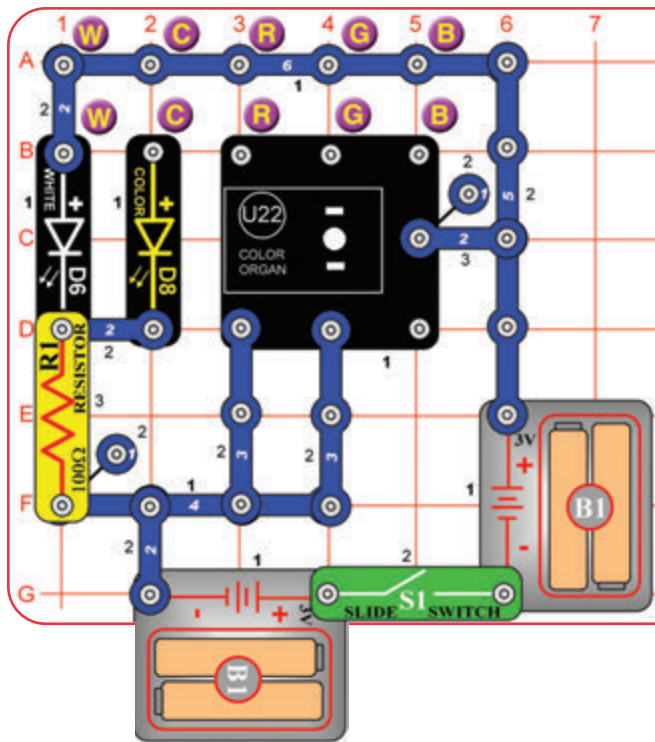

Build the circuit as shown, and turn on the switch (S1). The white LED (D6) will be on. Look at the white LED through the prismatic film to see the color spectrum of white light, which is all the colors of a rainbow. For best effects, do this in a dimly lit room.

Now remove the 2-snap across points W-W, and place it across points C-C (the color LED), then points R-R, G-G, and B-B (for the color organ). Using the prismatic film, look at the color spectrum produced by the color LED, and the different colors from the color organ. Compare them to the white LED spectrum.

Project 83 LED Color Spectrum (II)

Use the preceding circuit, but remove the 2-snap across points W-W and place 2-snaps across R-R and G-G. Use the prismatic film to look at the color spectrum. View from different directions and different angles.

Next, move the 2-snaps to R-R and B-B, and look at the spectrum. Then move the 2-snaps to G-G and B-B and look at the spectrum. View from different directions and different angles.

For each combination, the color spectrum should be mostly light of the 2 individual colors you are combining.

Project 84 LED Color Spectrum (III)

Use the preceding circuit, but place 2-snaps across points R-R, G-G, and B-B. Use the prismatic film to look at the color spectrum. View from different directions and different angles.

With the above connections, the color organ (U22) produces white light. The actual color spectrum you see will vary with your viewing angle, because the light is produced using separate red, green, and blue LEDs next to each other.

Now remove the 2-snaps from R-R, G-G, and B-B, and place one across W-W, so the circuit is like the project 82 drawing. Use the prismatic film to view the color spectrum from the white LED (D6) again, and compare it to the white light spectrum from U22. The D6 spectrum does not vary as much with the viewing angle because the light is produced by a single LED, and it is brighter.

Project 85 LED Color Spectrum (IV)

Use the circuit combinations from projects 82-84, but look at the different lights through the red, green, or blue filters instead of the prismatic film. Each filter only allows you to see light of that color, and blocks the other colors. If you put all three filters together then all light is blocked.

Actually, the red filter will pass a little of the green light, the blue filter will pass a little of the green light, and the green filter will pass a little of the green and blue light. This is because green light is between red and blue light in the color spectrum, and the filters are not perfect. See page 13 for more information about the color spectrum.

Project 86 LED Color Spectrum (V)

Repeat project 82, but place the black fiber optic cable holder with the fiber optic cable on the LED you want to view. Look at the light coming out the other end of the cable using the prismatic film, and view in a dimly lit room. The light is not as bright but the beam is narrower, so the color spectrum may be clearer.

Project 87 Blinking Beeping

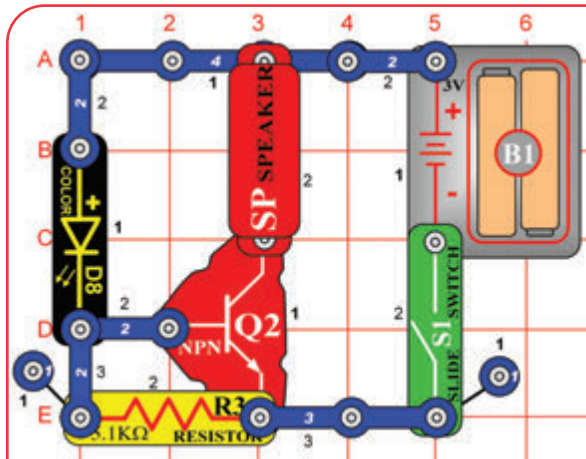

Build the circuit as shown and turn on the switch (S1). The color LED (D8) will be blinking and you hear beeping from the speaker. The sound will not be very loud.

The color LED (D8) has a microcircuit that changes the light colors. As it does this, it changes the current through the circuit. The transistor (Q2) amplifies the changing current and uses it to control the speaker (SP).

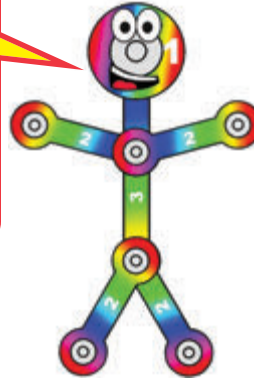

Project 88

Blinking Blinking

Use the preceding circuit, but replace the speaker with the red LED (D1). Now the red LED will also be blinking.

Project 89 Blinking Control

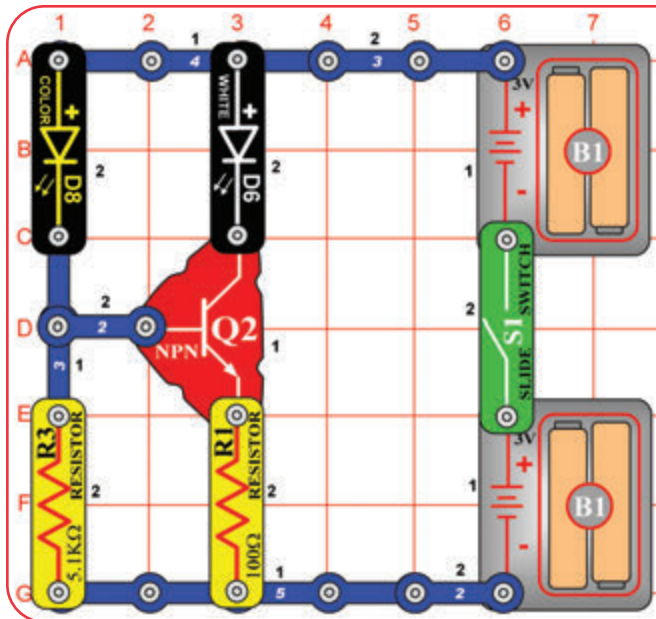

Build the circuit as shown and turn on the switch (S1). The color LED (D8) and white LED (D6) will both be blinking. The color LED will be brighter than in the preceding circuit.

The white LED is controlled by the color LED using the transistor (Q2). If you remove the color LED from the circuit then the white LED will not blink.

Project 90 Blinking Control Beeping

Use the preceding circuit, but replace the white LED (D6) with the speaker (SP). Now the blinking LED controls a beeping sound, but the sound will not be very loud.



Project 91

Triple Blinker

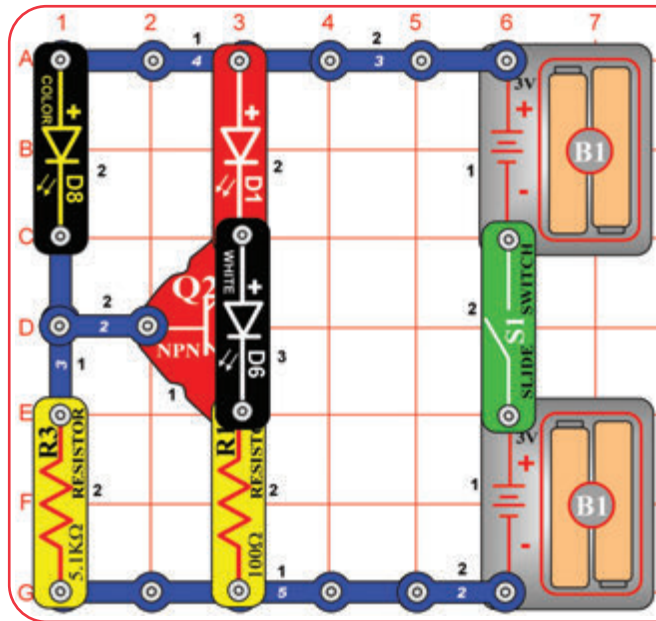

Build the circuit as shown and turn on the switch (S1). Three LEDs (D1, D6, and D8) will be blinking.

The red and white LEDs are controlled by the color LED using the transistor (Q2). If you remove the color LED from the circuit then the other LEDs will not blink.



Project 92 Funny Speed Motor

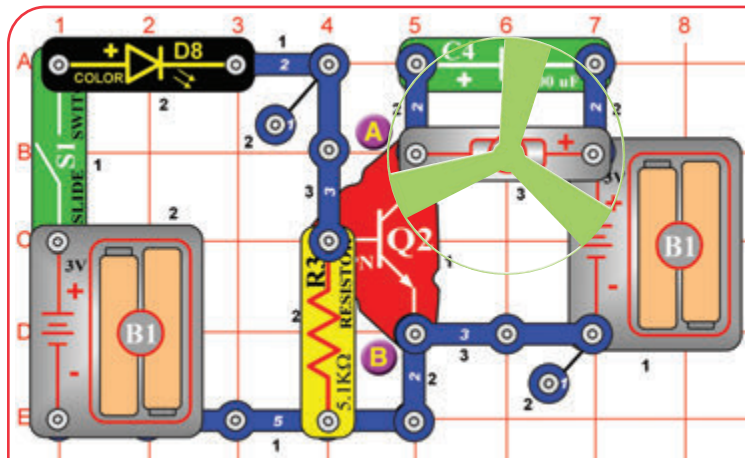

Build the circuit as shown and turn on the switch (S1). The color LED (D8) is blinking and the motor (M1) spins at different speeds. Try this circuit with the glow fan on the motor, and without the fan.

The motor is controlled by the color LED using the transistor (Q2). If you remove the color LED from the circuit then the motor will not spin.

In this circuit the color LED is powered by one set of batteries, and the motor is powered by different set. This was done because the motor produces electrical pulses as it spins, and these pulses can confuse the color LED.



Project 93 Funny Speed Motor with Light

Use the preceding circuit, but add the red LED (D1) across points A & B ("+" to A). This adds another blinking light.

WARNING: Moving parts. Do not touch the fan or motor during operation.



Project 94

Light Dance Audio Override

LED Attachments

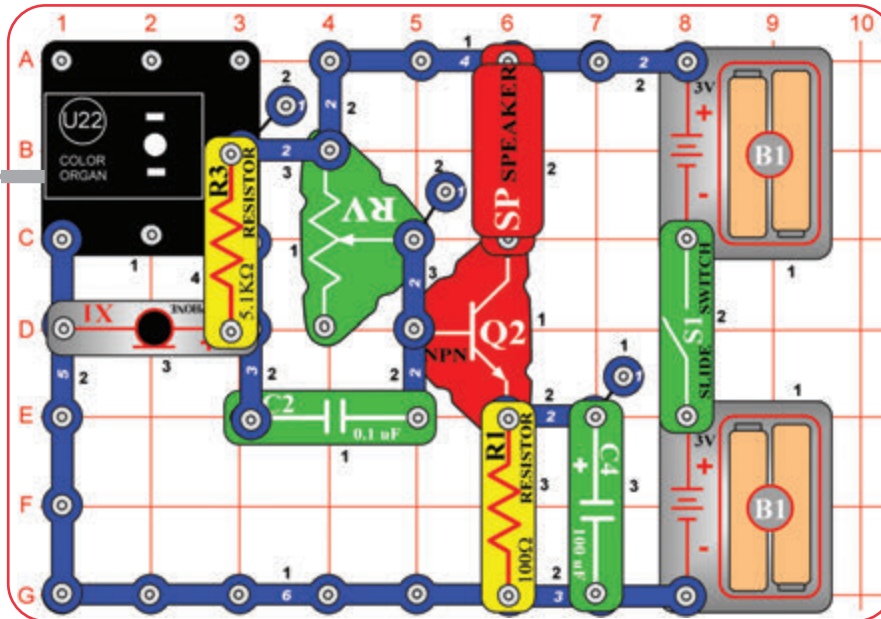
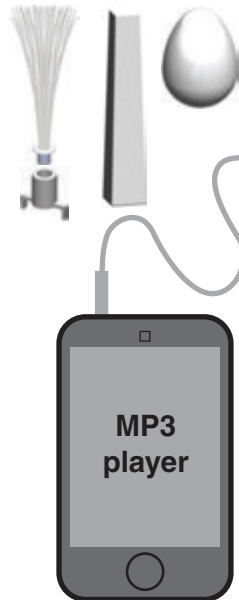

Build the circuit, which is similar to project 34 (Dance to the Music). Connect a music device (not included) to the color organ (U22) as shown, and start music on it. Place one of the LED attachments over the light on the color organ. Set the lever on the adjustable resistor (RV), and the volume control on your music device, for best sound quality and light effects. The color organ light will “dance” in synch with the music.

For the next part, you need the color organ light to be changing slowly. Set your music device to play a song with a slow beat, and set the volume control on it so the sound is not very loud.

Now blow on the microphone (X1) or talk loud directly into it. The dancing light pattern should be interrupted by your blowing/talking. If you don’t notice any difference then lower the volume control on your music device. Songs with a slower beat work best for this.



Project 95

Light Dance Light Override

LED Attachments

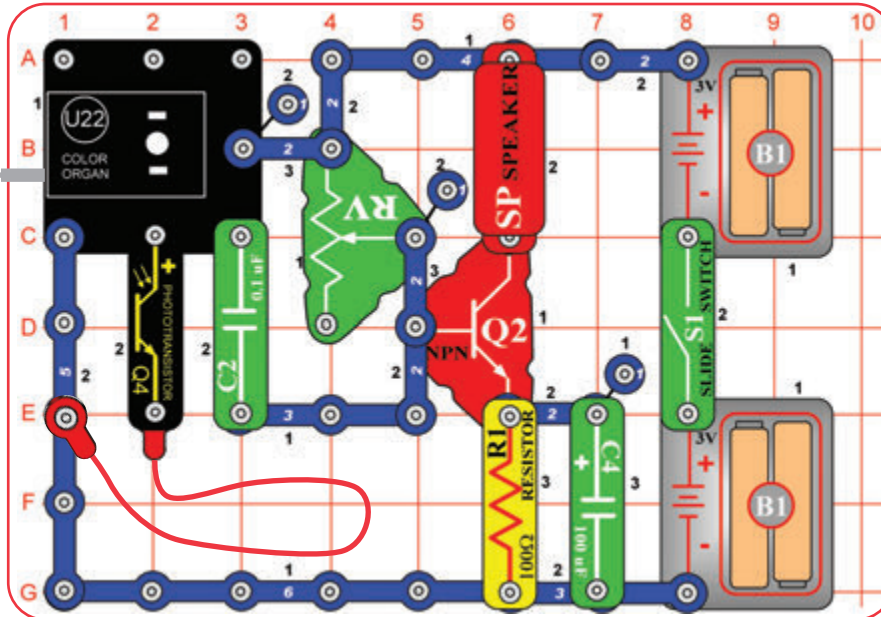
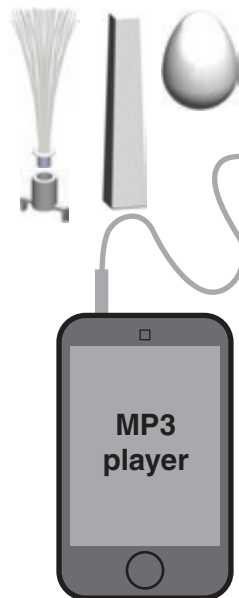

Build the circuit, which is similar to project 34 (Dance to the Music). Connect a music device (not included) to the color organ (U22) as shown, and start music on it. Place one of the LED attachments over the light on the color organ. Cover the phototransistor (Q4) with your hand and set the lever on the adjustable resistor (RV), and the volume control on your music device, for best sound quality and light effects. The color organ light will “dance” in synch with the music.

Uncover the phototransistor and shine a bright light on it. The color organ light will stop changing until you re-cover the phototransistor. The music will not be affected.



Project 96

Counting Light

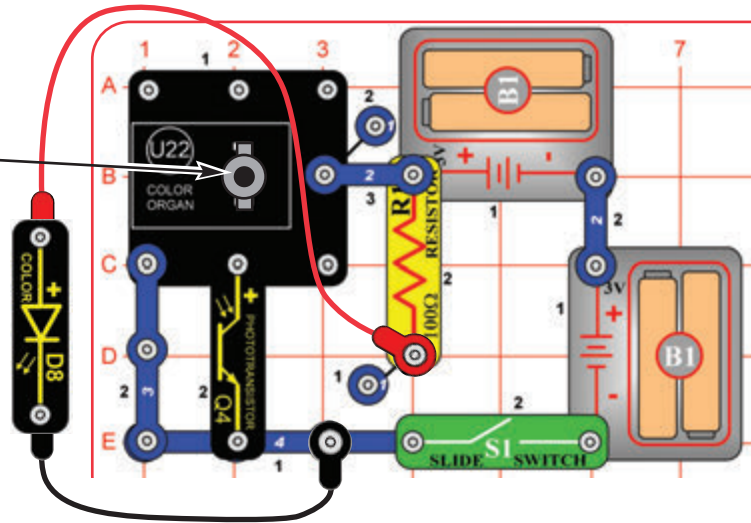

The color organ is counting how many times light turns the phototransistor on or off. At some count levels, the color organ changes colors.



Build the circuit as shown and turn on the switch (S1). Place one of the LED attachments over the LED on the color organ (U22). Connect the color LED (D8) using the red & black jumper wires and hold it just above the phototransistor (Q4), so that it shines directly into the phototransistor. For best effects, do this in a dimly lit room. Every few seconds, the color organ light will change colors.



Project 97

Adjustable Counting Light

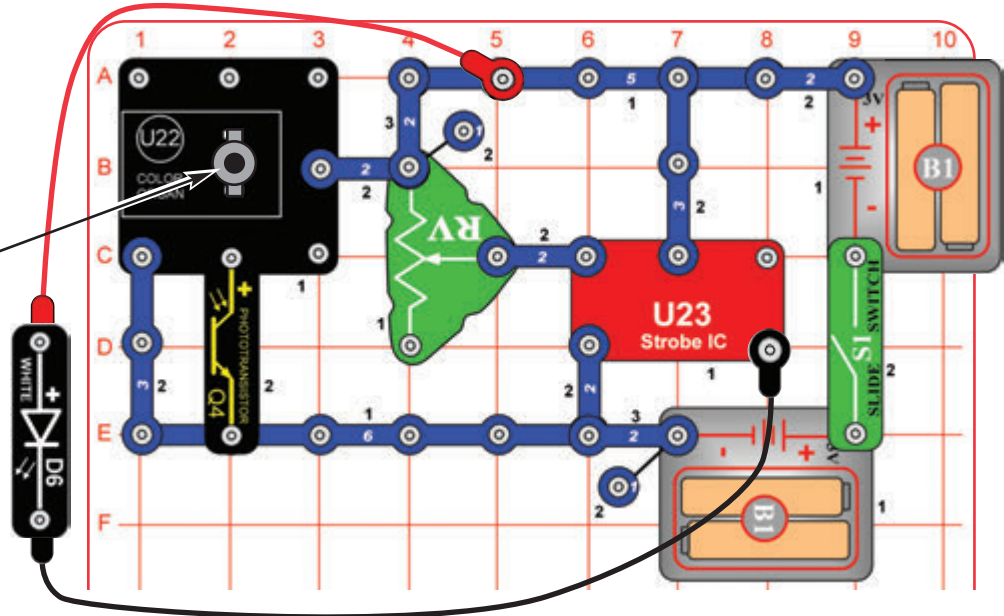

Build the circuit as shown and turn on the switch (S1). Place one of the LED attachments over the LED on the color organ (U22). Connect the white LED (D6) using the red & black jumper wires and hold it just above the phototransistor (Q4), so that it shines directly into the phototransistor. For best effects, do this in a dimly lit room. The color organ light will change colors, the lever on the adjustable resistor (RV) controls how fast the colors change.



Project 98

Bright Off Light

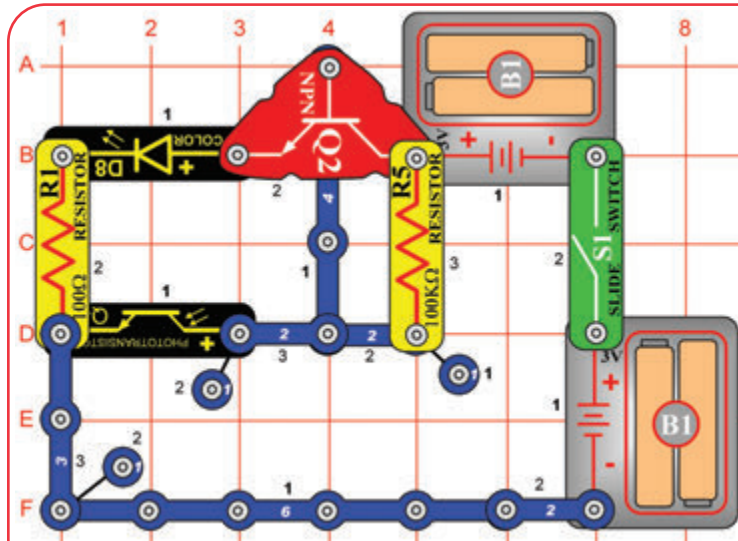

Build the circuit as shown and turn on the switch (S1). Place the circuit in a dark room or cover the phototransistor (Q4); the color LED (D8) should be on. Shine light on the phototransistor and the color LED turns off.



Project 99

R/C Blink & Beep

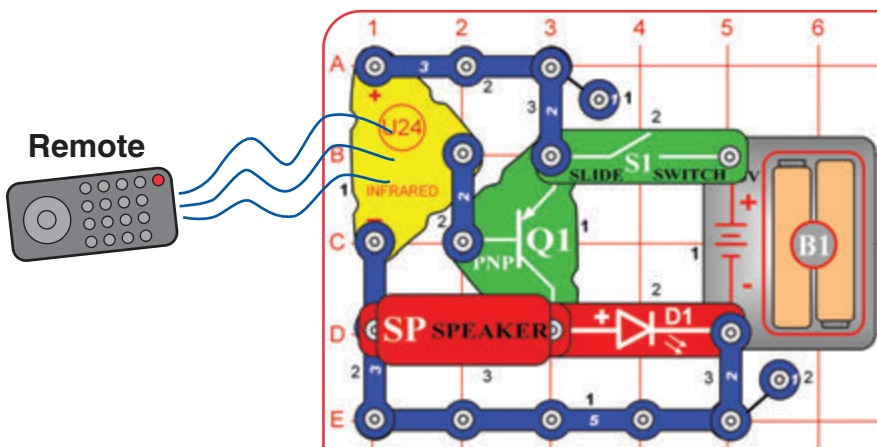

You need an infrared remote control for this project, such as any TV/stereo/DVD remote control in your home.

Build the circuit and turn on the switch (S1). Point your remote control toward the infrared module (U24) and press any button to activate the red LED (D1) and speaker (SP).

Project 100

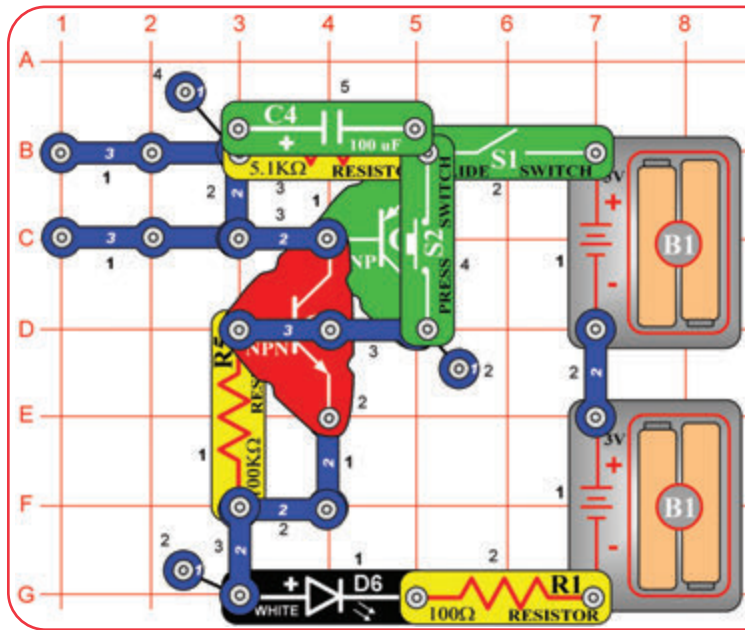

Stuck On Light

Build the circuit as shown, and note that several parts are stacked over others. Turn on the slide switch (S1); nothing happens.

Now push the press switch (S2); the white LED (D6) turns on and stays on. The white LED will stay on until you turn off the slide switch.

The two transistors act as an electronic device called an SCR (Silicon Controlled Rectifier). An SCR is a three-pin device that once its control pin is triggered, remains on until the current flow through it stops.



Project 101 Stuck On Lights

Use the preceding circuit, but replace the 100Ω resistor (R1) with the color LED (D8) or the red LED (D1).

Project 102 White Blinker

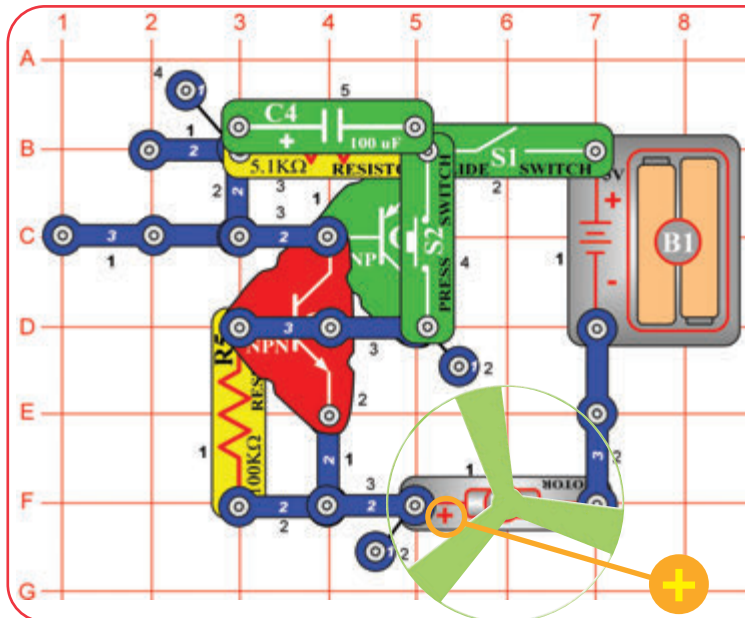

Build the circuit as shown, and note that several parts are stacked over others. Turn on the slide switch (S1); nothing happens.

Now push the press switch (S2); the motor (M1) turns on and stays on. The motor will stay on until you turn off the slide switch.

WARNING: Moving parts. Do not touch the fan or motor during operation.

Project 103 Low Voltage Stuck On Lights

Use the preceding circuit, but replace the motor with the red LED (D1).

Project 104 Stuck On Motor & Lights

Use the project 102 circuit but place the red LED (D1) next to the motor at base grid locations G5-G7 ("+" to G5). Connect the red LED to the adjacent points on the motor using the red & black jumper wires, making sure the jumper wires do not touch the motor or fan.

Turn on the slide switch (S1), then push the press switch (S2). The motor spins and the red LED is dim. Turn off the circuit, remove the fan from the motor, and turn the circuit back on. Now the red LED is bright because it takes less electricity to spin the motor without the fan, leaving more electricity for the red LED.

Project 105 Funky Light & Sound

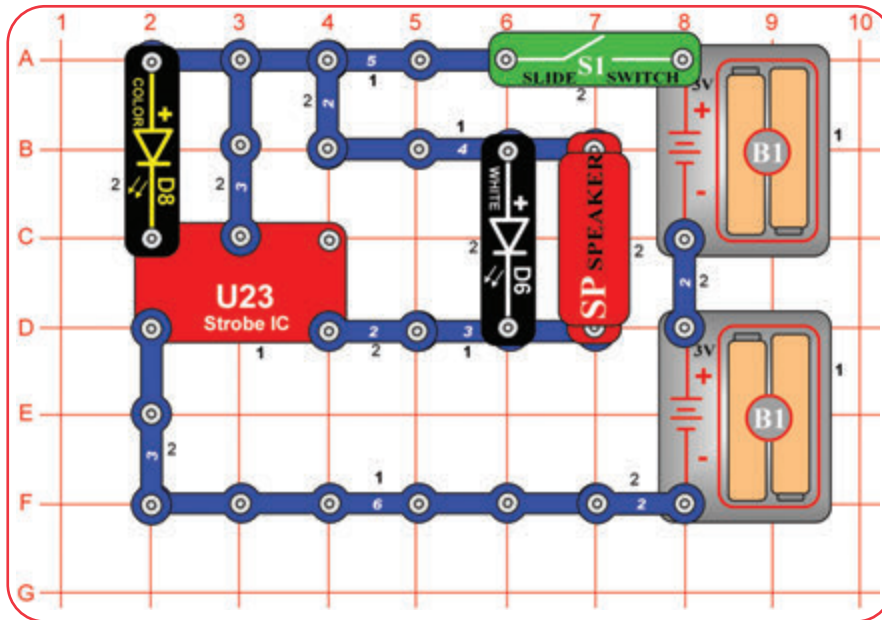

Build the circuit as shown and turn on the switch (S1). The color LED (D8) is used to control the strobe IC (U23), producing unusual effects.

Project 106 Light & Sound

Use the preceding circuit, but replace the color LED (D8) with the 100kΩ resistor (R5) or the 5.1kΩ resistor (R3).

Project 107 Light & Motion

Repeat projects 105 & 106 but replace the speaker with the motor (M1) and glow fan (motor "+" toward S1).

WARNING: Moving parts. Do not touch the fan or motor during operation.

Project 108 Adjustable Light & Sound

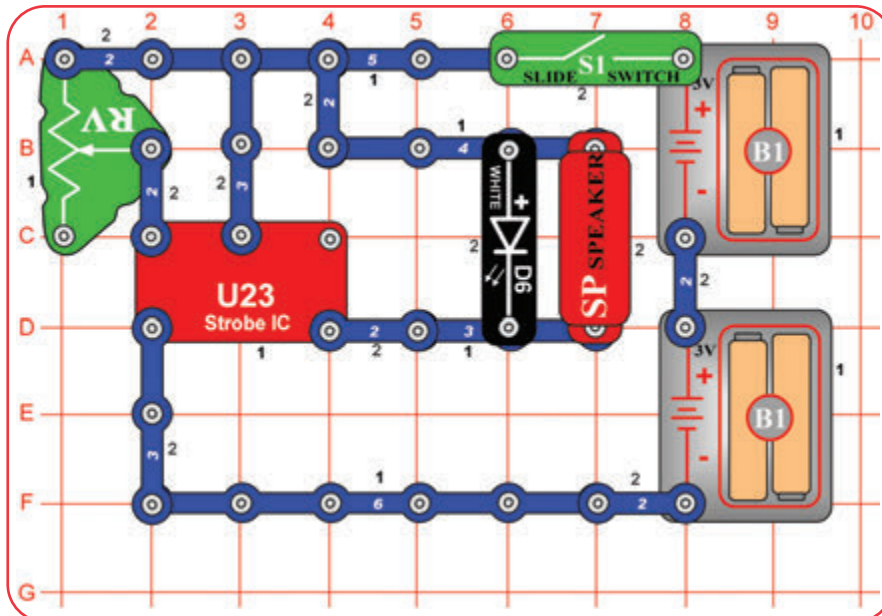

Modify the preceding circuit to match the one shown here. Use the lever on the adjustable resistor (RV) to control the light & sound. At some settings the white LED (D6) will not light, or will appear to be on continuously.

Project 109 Adjustable Light & Motion

Use the preceding circuit, but replace the speaker with the motor (M1) and glow fan (motor "+" toward S1).

WARNING: Moving parts. Do not touch the fan or motor during operation.

Project 110

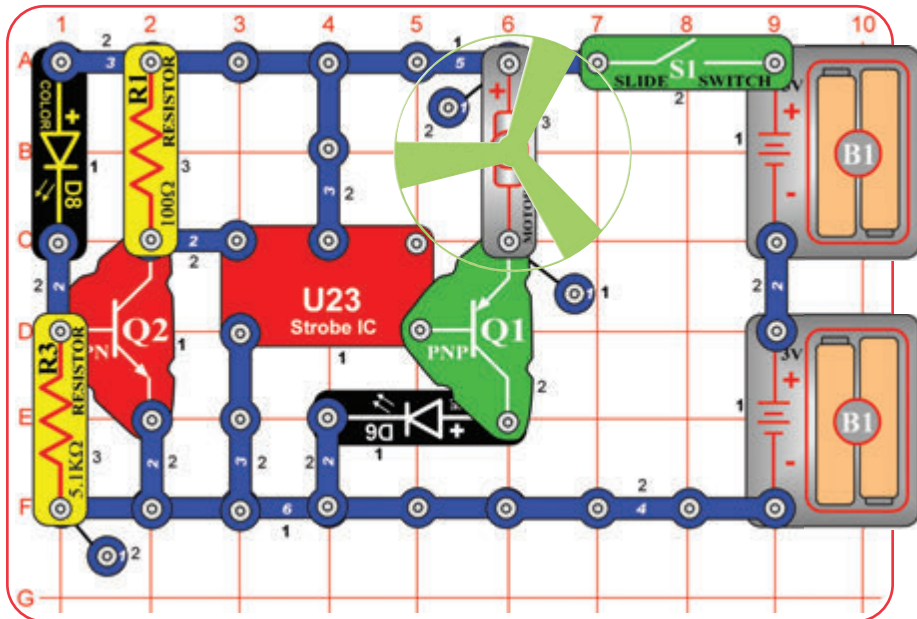

Blinking Step Motor

Build the circuit as shown and turn on the switch (S1). The color LED (D8) is used to control the strobe IC (U23), which turns on the motor (M1) in short bursts.

To have 3 LEDs, place the red LED (D1) directly over the white LED (D6).

Project 111

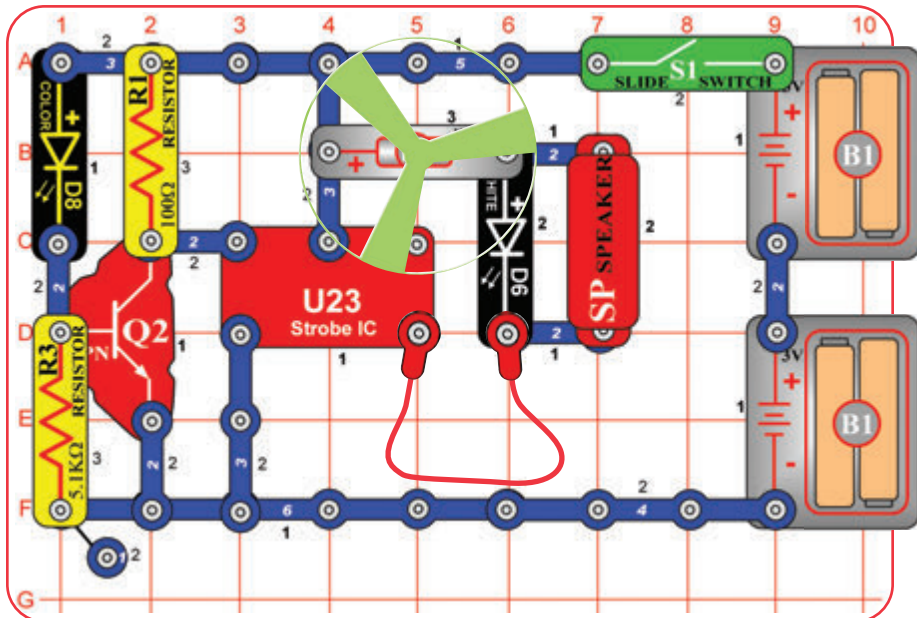

Blink Step Beep

Build the circuit as shown and turn on the switch (S1). The color LED (D8) is used to control the strobe IC (U23), which turns on the motor (M1), white LED (D6), and speaker (SP) in short bursts. The circuit also works without the fan on the motor.

If you replace the motor with the black jumper wire, the white LED will be a little brighter.



WARNING: Moving parts. Do not touch the fan or motor during operation.



Project 112 Day Blinker

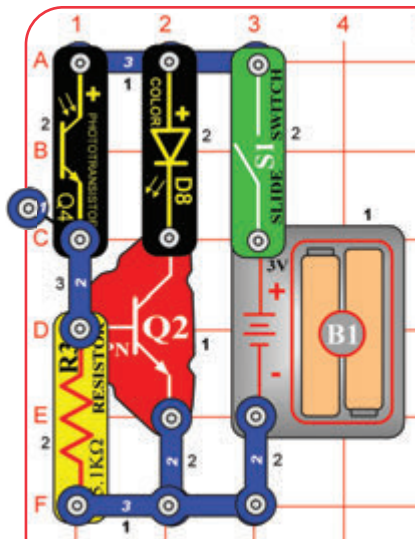

Build the circuit as shown and turn on the switch (S1). The color LED (D8) is on when there is light on the phototransistor (Q4). Shine light on or cover the phototransistor to turn the color LED on or off.



Project 113 Night Blinker

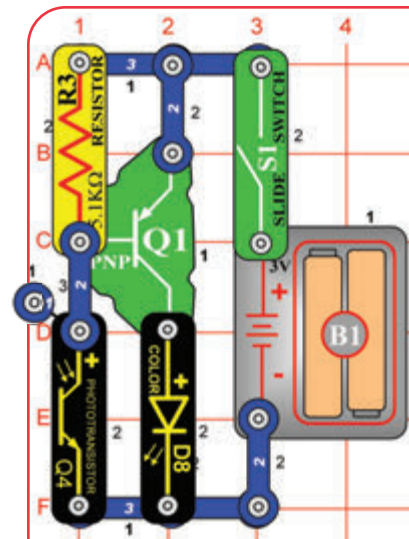

Build the circuit as shown and turn on the switch (S1). The color LED (D8) is off when there is light on the phototransistor (Q4). Cover or shine light on the phototransistor to turn the color LED on or off.



Project 114 Night Light Show

LED Attachments

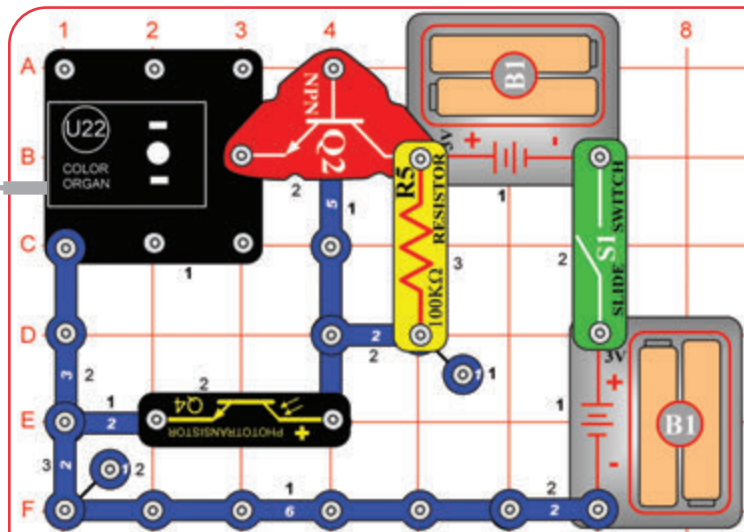
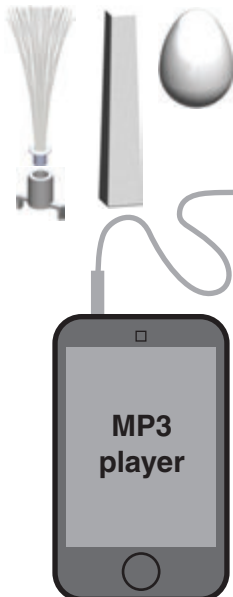

Build the circuit as shown. Connect a music device (not included) to the color organ (U22) as shown, and start music on it. Place one of the LED attachments over the light on the color organ. Turn on the switch (S1), then cover the phototransistor (Q4) to see a light show. Adjust the volume on your music device for best light effects.



Project 115 Daylight Light Show

Use the preceding circuit, but swap the locations of the phototransistor (Q4) and the 100kΩ resistor (R5), keep the "+" side of Q4 in the same direction. Now covering the phototransistor turns off the light show.

Project 116 Buzzer

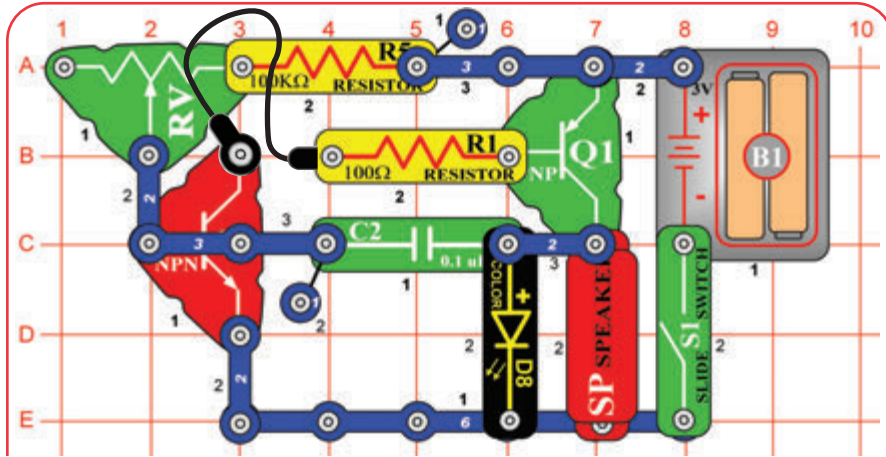

This circuit is an oscillator, which uses feedback to control the pitch of the sound.



Build the circuit as shown and turn on the switch (S1). Move the lever on the adjustable resistor (RV) to vary the pitch of the buzzing sound.

Project 117 Light & Sound

Use the preceding circuit, but place the 5.1kΩ resistor directly over the 100kΩ resistor using a 1-snap. The pitch of the tone is higher now, but the circuit may not make noise on all settings for the adjustable resistor.

Project 118 Light & Motion

Use the projects 116-117 circuits, but add the phototransistor (Q4) across base grid locations B2-B4 (between RV and R1, "+" on the left), on level 3. Vary the amount of light on the phototransistor to change the sound, while also varying RV.

Project 119 Adjustable Light & Motion

Use the projects 116-117 circuits, but replace the 0.1µF capacitor (C2) with the 100µF capacitor (C4), "+" to the right. Turn the switch on and patiently wait. The speaker will beep and the color LED (D8) will flash every 5-20 seconds, depending on the resistors.

Project 120 Light Up the Fan

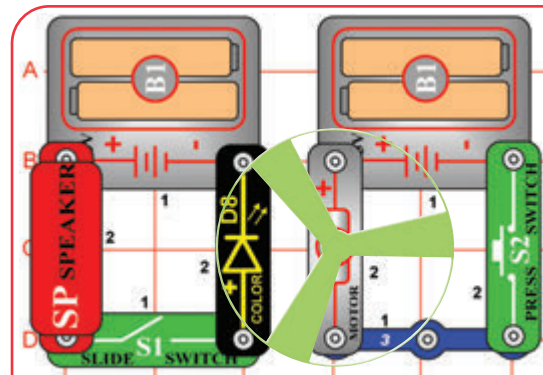

Build the circuit as shown, place the glow fan on the motor (M1), and turn on the slide switch (S1). Place the circuit in a dark room and push the press switch (S2) to spin the fan. The color LED (D8) lights up the spinning fan.

The circuit with the color LED is not electrically connected to the circuit with the motor. This was done because the motor produces electrical pulses as it spins, and these pulses can confuse the color LED.

WARNING: Moving parts. Do not touch the fan or motor during operation.





Project 121 High Power Buzzer

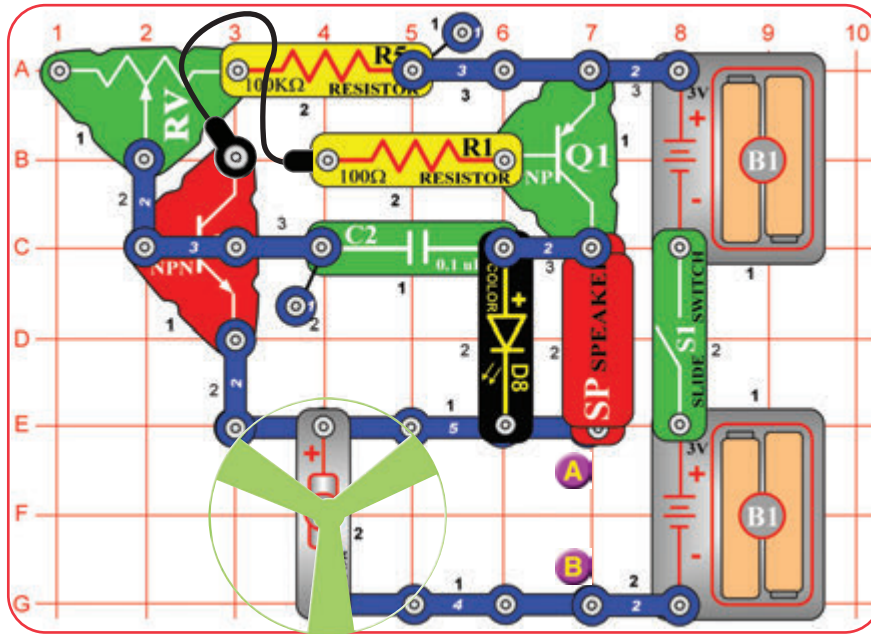

WARNING: Moving parts. Do not touch the fan or motor during operation.

Build the circuit as shown and turn on the switch (S1). Move the lever on the adjustable resistor (RV) to vary the pitch of the buzzing sound. The motor (M1) will not spin.



Project 122 Buzz Fan

Use the preceding circuit, but place the 5.1kΩ resistor directly over the 100kΩ resistor using a 1-snap. The pitch of the tone is higher now, and the fan spins. The circuit may not make noise on all settings for the adjustable resistor.



Project 123 Light & Motion

Use the circuits from projects 121-122, but add the phototransistor (Q4) across base grid locations B2-B4 (between RV and R1, "+" on the left), on level 3. Shine a bright light on the phototransistor to change the sound, while also moving the lever on RV.



Project 124 Step Beeper

Use the circuits from projects 116-117, but replace the 0.1µF capacitor (C2) with the 100µF capacitor (C4), "+" to the right. The motor will move in small bursts, with long intervals or almost continuously, depending on the resistors and phototransistor.

Next, replace the color LED (D8) with the white LED (D6). See how the circuit works now.



Project 125 Wacky Buzzer

Repeat projects 121-123, but add the 100µF capacitor (C4) across the points marked A & B in the drawing ("+" to A). The motor may not spin but the sound is different.

Project 126

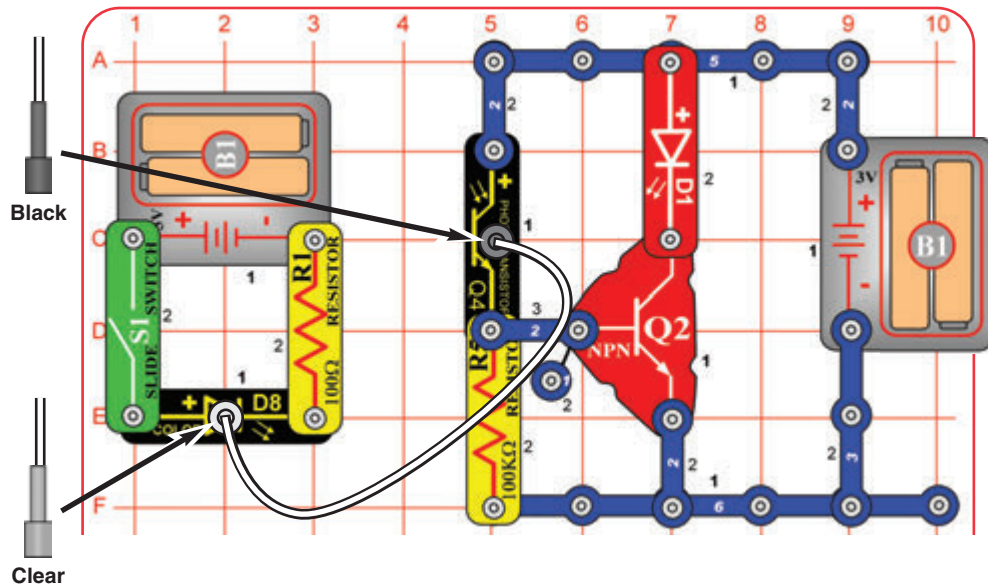

Fiber Fun

Build the circuit as shown. Place the clear cable holder on the color LED (D8) and the black cable holder on the phototransistor (Q4), then place the fiber optic cable into the holders as far as it will go.

Turn on the slide switch (S1). Light is transmitted from the color LED, through the fiber optic cable, to control the NPN transistor (Q2) and red LED (D1).

You can replace the red LED with the white LED (D6), but the white LED may be dim or not light.

Project 127 Fiber Fun Backwards

Use the preceding circuit but swap the locations of the phototransistor (Q4) and the 100kΩ resistor (R5), keep the "+" side of Q4 in the same direction. Now the red LED will be on whenever the color LED is on.

Project 128

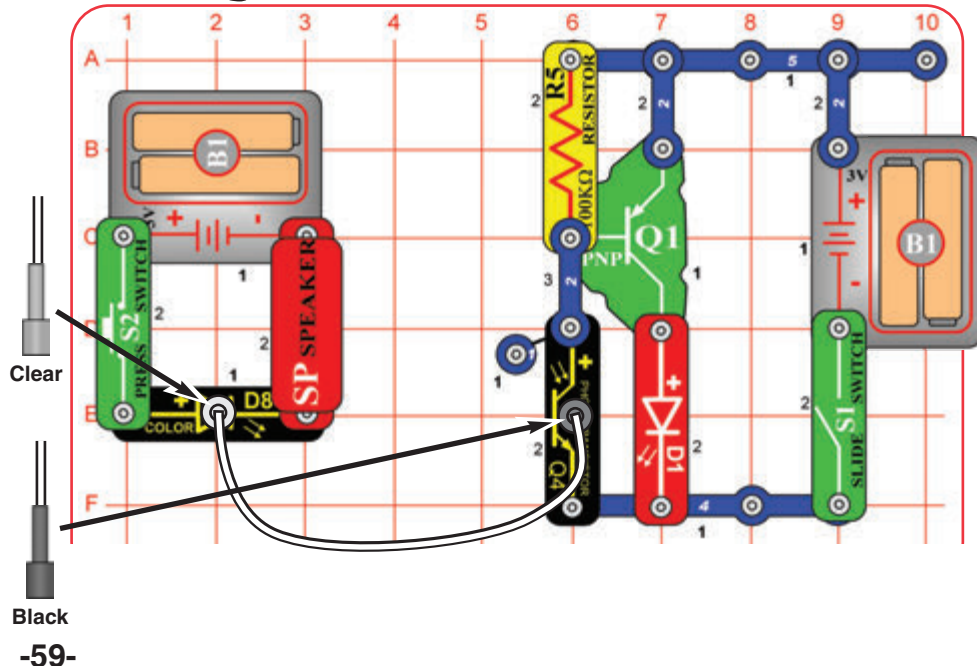

More Fiber Fun

Build the circuit as shown. Place the clear cable holder on the color LED (D8) and the black cable holder on the phototransistor (Q4), then place the fiber optic cable into the holders as far as it will go. For best performance the fiber optic cable should stand straight up in the holders, without bending them.

Turn on the slide switch (S1). Light is transmitted from the color LED, through the fiber optic cable, to control the NPN transistor (Q2) and red LED (D1). The speaker is used to help limit the current through the color LED, and will not make noise.

For more fun, swap the locations of the color LED (D8) and red LED (D1). You may also replace either LED with the white LED (D6), but the white LED may be dim or not light.

Project 129 Other Fiber Fun

Use the preceding circuit but swap the locations of the phototransistor (Q4) and the 100kΩ resistor (R5), keep the "+" side of Q4 in the same direction. Now the red LED will be on whenever the color LED is on.



Project 130

Morse Code

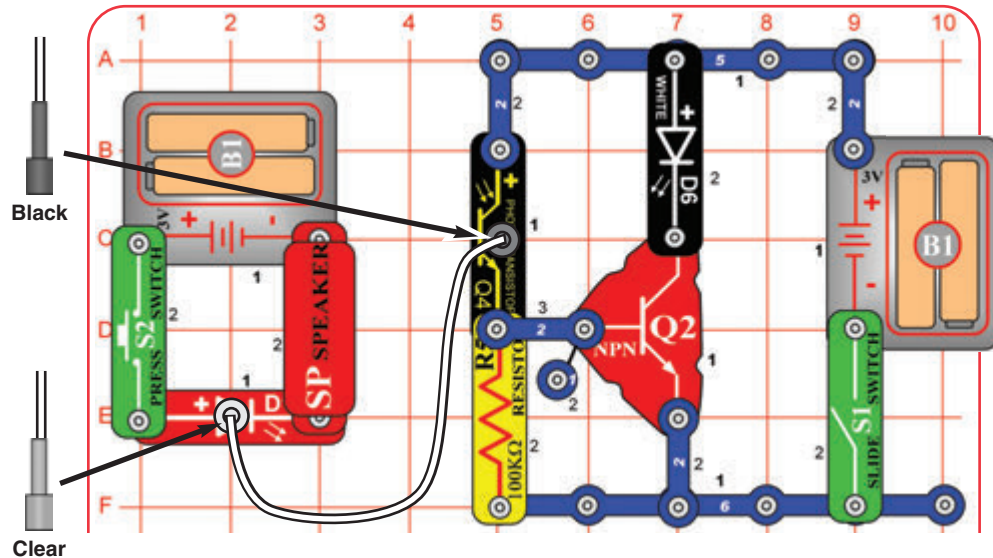

Build the circuit as shown. Place the clear cable holder on the red LED (D1) and the black cable holder on the phototransistor (Q4), then place the fiber optic cable into the holders as far as it will go. For best performance the fiber optic cable should stand straight up in the holders, without bending them. Turn on the slide switch (S1), then push the press switch (S2) several times to send secret messages between the circuits using Morse Code. If your fiber optic cable was a lot longer, you could use this circuit to send messages to your friends in different cities. The speaker is used to help limit the current through the red LED, and will not make noise.

If desired, you can swap the locations of the red and white LEDs (D1 & D6).

Note: If the white LED (D6) does not light or is dim, replace it with the color LED (D8). The white LED can be brighter and won't change colors, but requires higher voltage to activate.

Morse Code: The forerunner of today's telephone system was the telegraph, which was widely used in the latter half of the 19th century. It only had two states - on or off (that is, transmitting or not transmitting), and could not send the range of frequencies contained in human voices or music. A code was developed to send information over long distances using this system and a sequence of dots and dashes (short or long transmit bursts). It was named Morse Code after its inventor. It was also used extensively in the early days of radio communications, though it isn't in wide use today. It is sometimes referred to in Hollywood movies, especially Westerns. Modern fiber optics communications systems send data across the country using similar coding systems, but at much higher speeds.

| MORSE CODE | |
|------------|-----------|
| A | · - |
| B | · · · · |
| C | - · - · |
| D | · - · - |
| E | · |
| F | · · - · |
| G | - · - · |
| H | · · · · |
| I | · · |
| J | - · - - |
| K | · - - · |
| L | · - · - |
| M | - - |
| N | - · |
| O | - - - |
| P | · - - · |
| Q | - · - - |
| R | · - · |
| S | · · · |
| T | - · - |
| U | · · - |
| V | · · · - |
| W | · - - - |
| X | - · - · |
| Y | - · - - |
| Z | - - · - |
| Period | · · · · - |
| Comma | · · · - - |
| Question | · · · - · |
| 1 | - · - - - |
| 2 | · - - - - |
| 3 | · · - - - |
| 4 | · - - - · |
| 5 | · · · · · |
| 6 | - · · · · |
| 7 | - - · · · |
| 8 | - · · · · |
| 9 | · - · · · |
| 0 | - - - - · |



Project 131

Fiber Shut-Off

Use the preceding circuit but swap the locations of the phototransistor (Q4) and the 100kΩ resistor (R5), keep the "+" side of Q4 in the same direction. Now pushing the press switch will turn off the LED in the right half of the circuit.



Project 132

Blow On Fiber

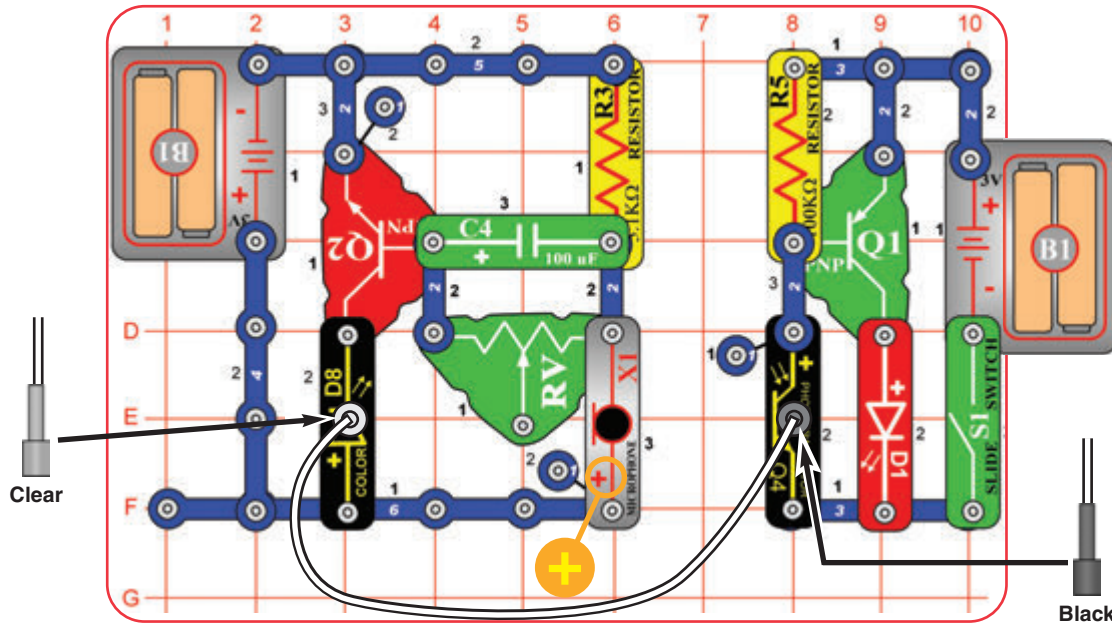

Build the circuit as shown. Place the clear cable holder on the color LED (D8) and the black cable holder on the phototransistor (Q4), then place the fiber optic cable into the holders as far as it will go. For best performance the fiber optic cable should stand straight up in the holders, without bending them.

Turn on the slide switch (S1), and blow on the microphone or talk loudly into it. The signal from the microphone will be sent through the fiber optic cable to the right half of the circuit, to activate the red LED (D1).



Project 133

Fiber Music

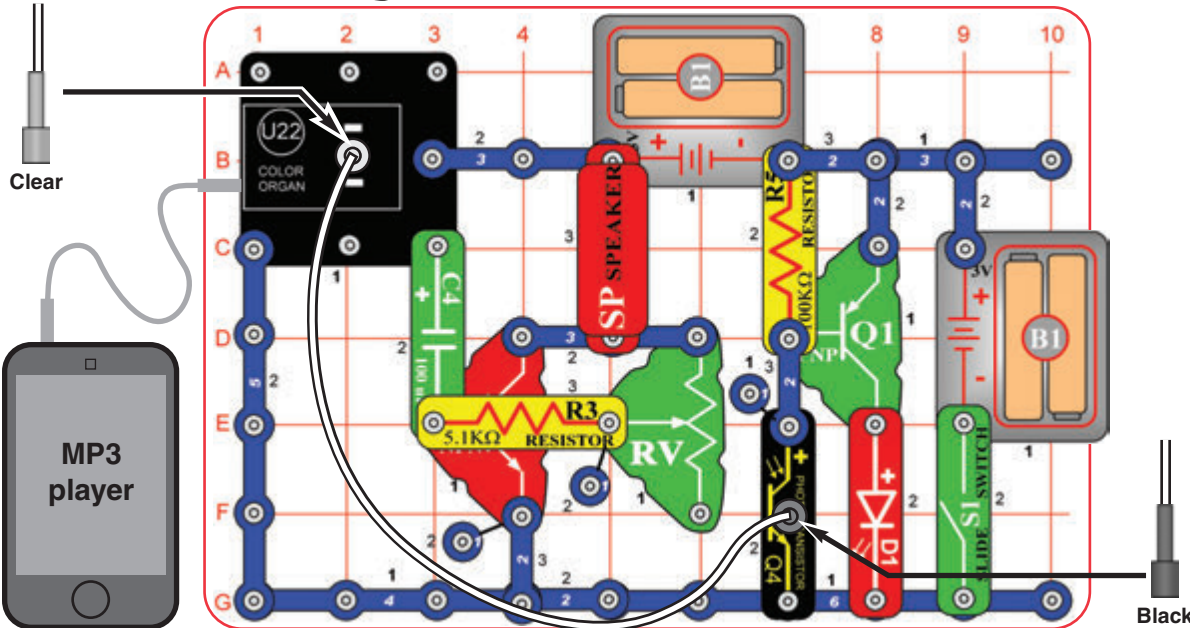

Build the circuit as shown. Place the clear cable holder on the color organ (U22) and the black cable holder on the phototransistor (Q4), then place the fiber optic cable into the holders as far as it will go. For best performance the fiber optic cable should stand straight up in the holders, without bending them. The clear holder will be a loose fit.

Connect a music device (not included) to the color organ as shown, and start the music on it. The music plays on the speaker (SP) while the LED on the color organ controls the red LED (D1) through the fiber optic cable. Set the volume control on your music device for best light & sound effects.

Project 134

Fiber Color Organ

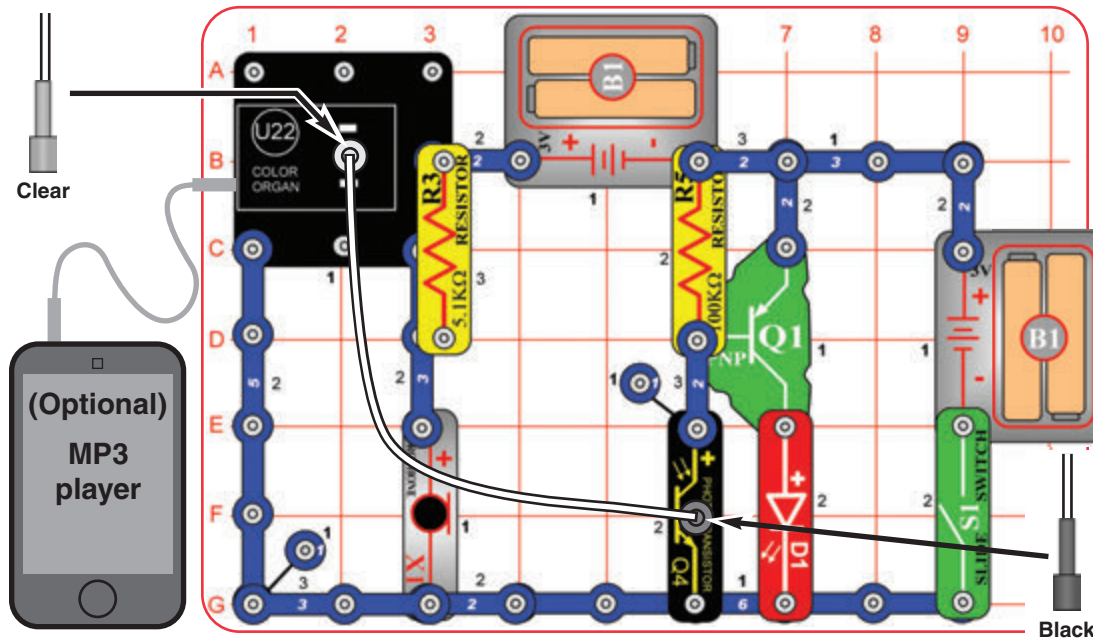

Build the circuit as shown. Place the clear cable holder on the color organ (U22) and the black cable holder on the phototransistor (Q4), then place the fiber optic cable into the holders as far as it will go. For best performance the fiber optic cable should stand straight up in the holders, without bending them. The clear holder will be a loose fit.

Turn on the slide switch (S1), and blow on the microphone or talk loudly into it. The signal from the microphone will change the LED on the color organ, then send the light through the fiber optic cable to the phototransistor, which controls the red LED (D1).

Optional: Connect a music device (not included) to the color organ as shown, and start the music on it. The music device will control the red LED. Set the volume control on your music device for best light effects. If you replace the red LED with the speaker (SP), then you get sound effects (beeping, not music).

Project 135

Bright Fiber Color Organ

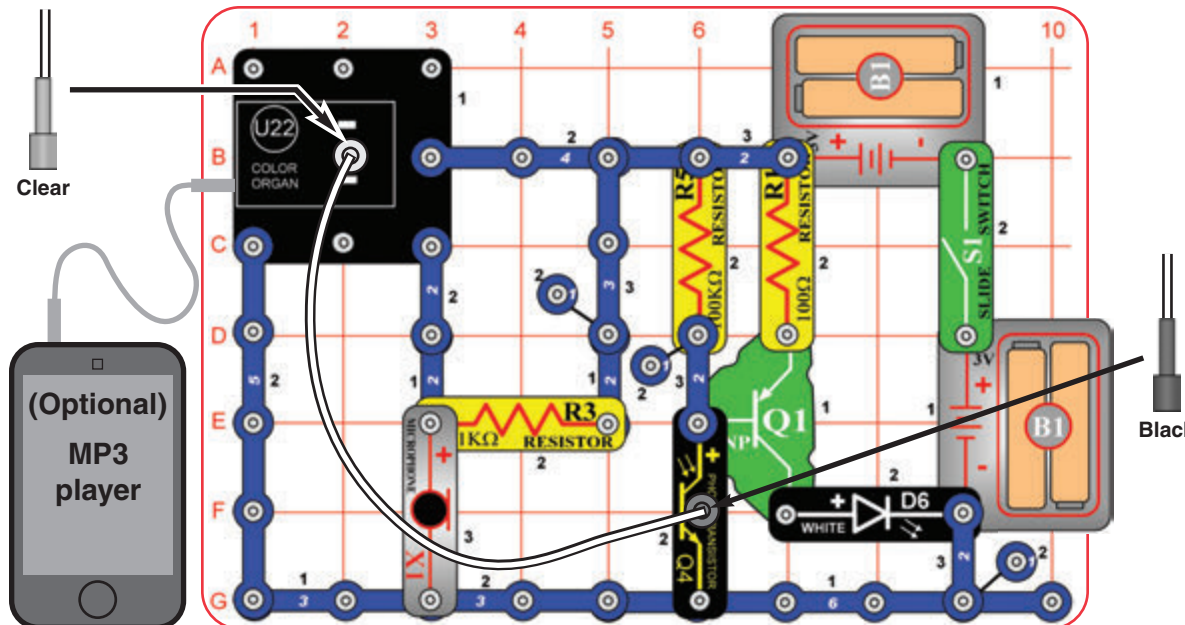

Build the circuit as shown. Place the clear cable holder on the color organ (U22) and the black cable holder on the phototransistor (Q4), then place the fiber optic cable into the holders as far as it will go. For best performance the fiber optic cable should stand straight up in the holders, without bending them. The clear holder will be a loose fit.

Turn on the slide switch (S1), and blow on the microphone or talk loudly into it. The signal from the microphone will change the LED on the color organ, then send the light through the fiber optic cable to the phototransistor, which controls the white LED (D6).

Optional: Connect a music device (not included) to the color organ as shown, and start the music on it. The music device will control the white LED. Set the volume control on your music device for best light effects.

Project 136 Motor Power

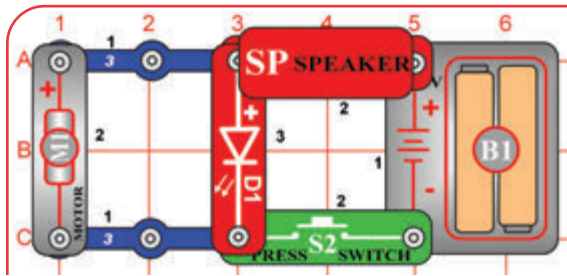

Build the circuit as shown, push the press switch (S2), and look at the brightness of the red LED (D1). Try it three ways: with no fan on the motor, with the glow fan on the motor, and keeping the motor from spinning with your fingers. When the motor is spinning, you will hear noise from the speaker (SP).

The motor needs a lot of electricity to start spinning, but needs less the faster it is spinning. When kept from spinning by your fingers, the motor sucks up all the electricity, leaving none to light the red LED. With the fan on the motor, the LED gets enough electricity to light. When the motor is spinning without the fan, the LED gets lots of electricity and is bright.



WARNING: Moving parts. Do not touch the fan or motor during operation.

Project 137 More Motor Power

Use the preceding circuit but replace the red LED (D1) with the color LED (D8) or the white LED (D6), see how they compare to the red LED.

The color and white LEDs need more electricity to light than the red LED. The motor "noise" that you hear on the speaker can also confuse the color LED and disrupt its color pattern.



Project 138 Reflection Detector

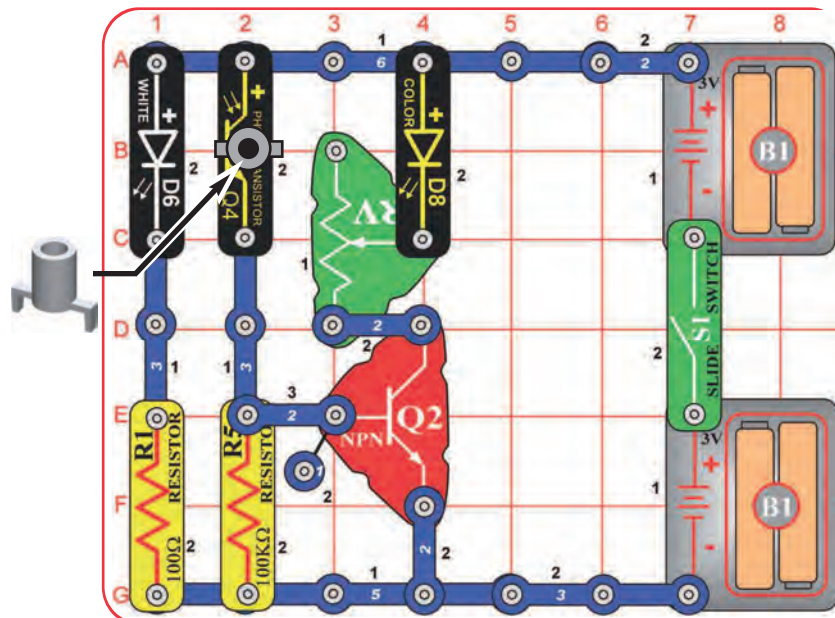

Reflection Detector

Build the circuit as shown and turn on the switch (S1). Set the lever on the adjustable resistor (RV) all the way toward the NPN transistor (Q2). Move the circuit into a dimly lit room, so that the color LED (D8) is off.

Place a mirror directly over the white LED (D6) and photo-transistor (Q4), or hold it facing a wall mirror. When enough light from the white LED reaches the phototransistor, the color LED will turn on, indicating that a reflection has been detected.

Project 139 Cup & String Communication

Light, radio signals, and sound all travel through air like waves travel through water. To help you understand how they are like waves, you can make a cup & string telephone. This common trick requires some household materials (not included with this kit): two large plastic or paper cups, some non-stretchable thread or kite string, and a sharp pencil. Adult supervision is recommended.

Take the cups and punch a tiny hole in the center of the bottom of each with a sharp pencil (or something similar). Take a piece of string (use between 25 and 100 feet) and thread each end through each hole. Either knot or tape the string so it cannot go back through the hole when the string is stretched. Now with two people, have each one take one of the cups and spread apart until the string is tight. The key is to make the string tight, so its best to keep the string in a straight line. Now if one of you talks into one of the cups while the other listens, the second person should be able to hear what the first person says.

How it works: When you talk into the cup, the cup bottom vibrates back and forth from your sound waves. The vibrations travel through the string by pulling the string back and forth, and then make the bottom of the second cup vibrate just like the first cup did, producing sound waves that the listener can hear. If the string is tight, the received sound waves will be just like the ones sent, and the listener hears what the talker said.

Telephones work the same way, except that electric current replaces the string. In radio, the changing current from a microphone is used to encode electromagnetic waves sent through the air, then decoded in a listening receiver.

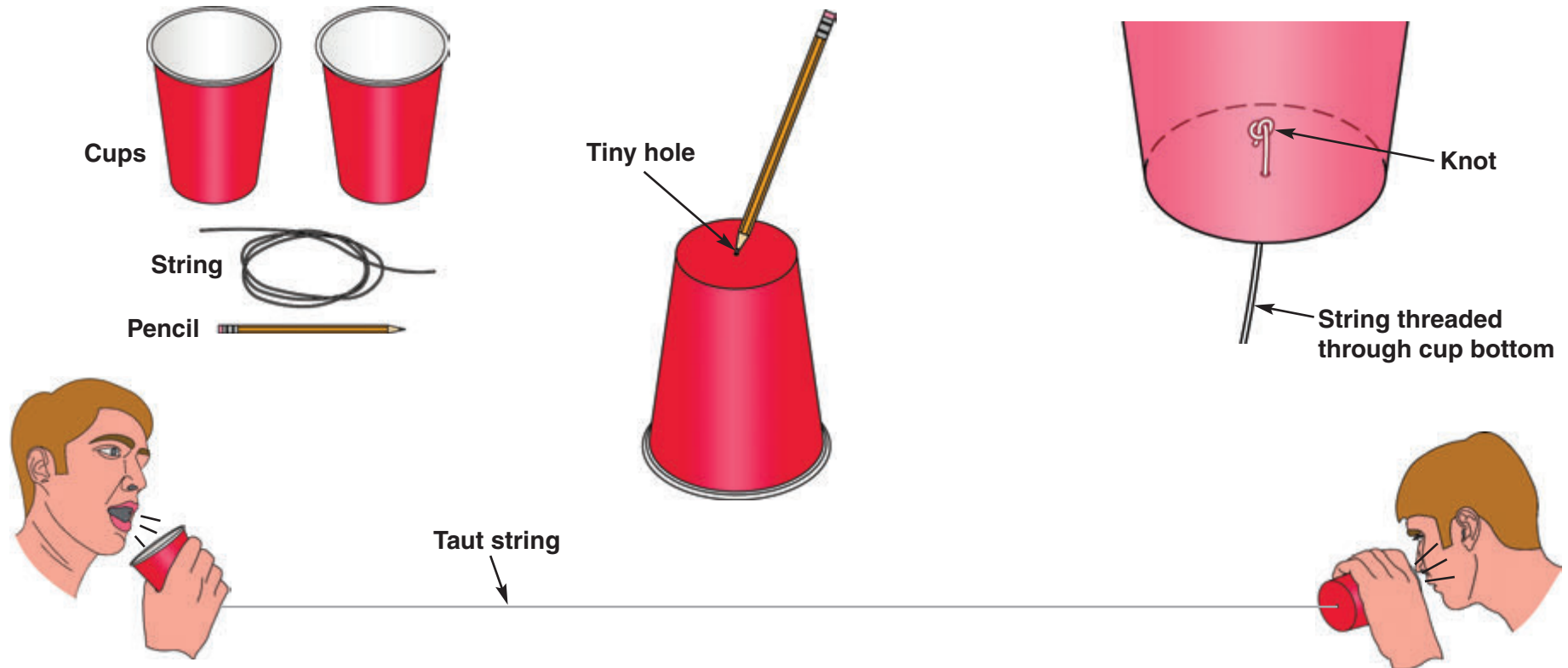

Project 140

Slow Motor Speed Control

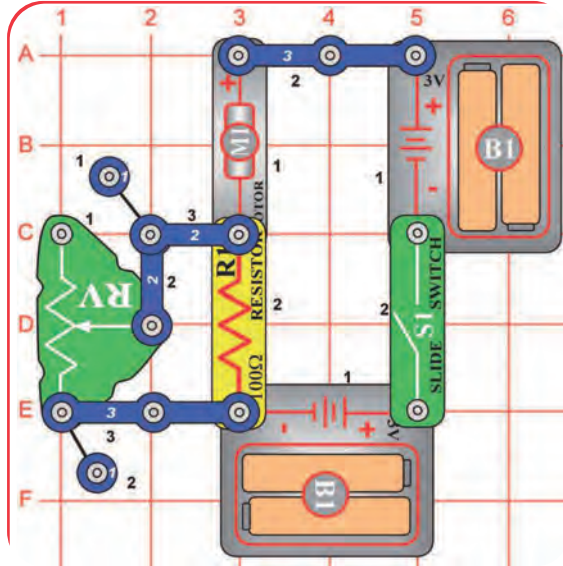

The motor needs a lot of electricity to start spinning, but needs less the faster it is spinning. The resistors (R1 & RV) are limiting how much electricity flows, so the motor can barely spin.



Build the circuit as shown; do not place the fan on the motor. Set the lever on the adjustable resistor (RV) toward the 3-snap. Turn on the switch (S1) to start the motor (M1). If the motor does not spin, then give it a push to get it started. Use the lever on the adjustable resistor to control the motor speed. If the motor does not spin even after giving it a push then replace your batteries.

Turn off the switch and turn the motor shaft counterclockwise with your fingers. Now turn the switch on try turning the motor counterclockwise; now it is harder because the circuit is trying to turn the motor clockwise at the same time.

Project 141

Slow Motor Start Aid

Use the preceding circuit but add the 100 μ F capacitor (C4) directly over the 100 Ω resistor (R1), "+" side towards the motor. The circuit works the same, but starts more easily.

If you have a larger 470 μ F capacitor (C5), which is included with some other Boffin sets, then you can use it in place of the 100 μ F capacitor. It will make the motor start even more easily.

The capacitor allows a short surge of electricity to flow through it until it charges up. This short surge bypasses the higher resistance of the resistors, and helps the motor get going.





Project 142

Series Lights

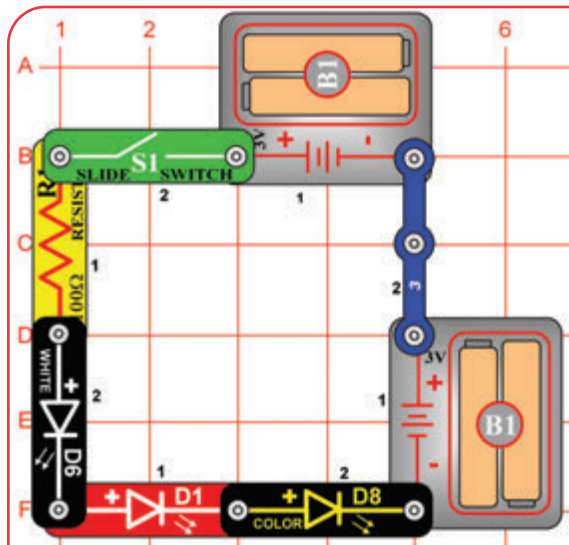

This circuit has all the parts connected in a series. Swapping the locations of any parts in the circuit (without changing the direction of their "+" side) will not change how the circuit works. Try it.

The LEDs are dim because the batteries need to overcome the activation voltage level for every LED in the series before any can light. That doesn't leave much voltage to overcome the resistance in the circuit. If you replace one of the LEDs with a 3-snap, the others will be much brighter. Try it.



Build the circuit as shown; do not place the fan on the motor. Set the lever on the adjustable resistor (RV) toward the 3-snap. Turn on the switch (S1) to start the motor (M1). If the motor does not spin, then give it a push to get it started. Use the lever on the adjustable resistor to control the motor speed. If the motor does not spin even after giving it a push then replace your batteries.

Turn off the switch and turn the motor shaft counterclockwise with your fingers. Now turn the switch on try turning the motor counterclockwise; now it is harder because the circuit is trying to turn the motor clockwise at the same time.



Project 143

Wacky Sound Control

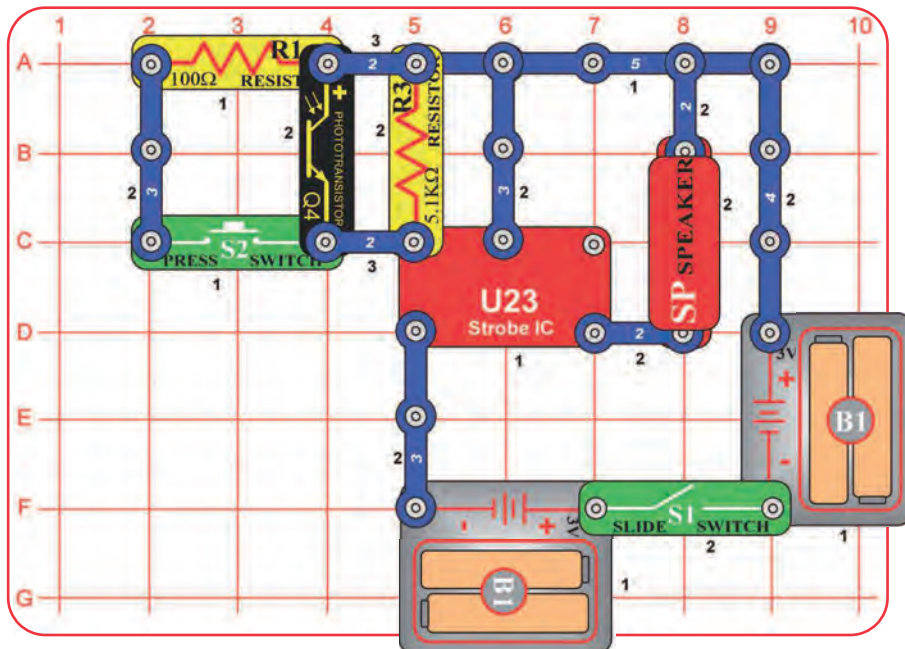

Build the circuit and turn on the slide switch (S1). Vary the amount of light on the phototransistor (Q4) and push the press switch (S2) to change the sound.



Project 144

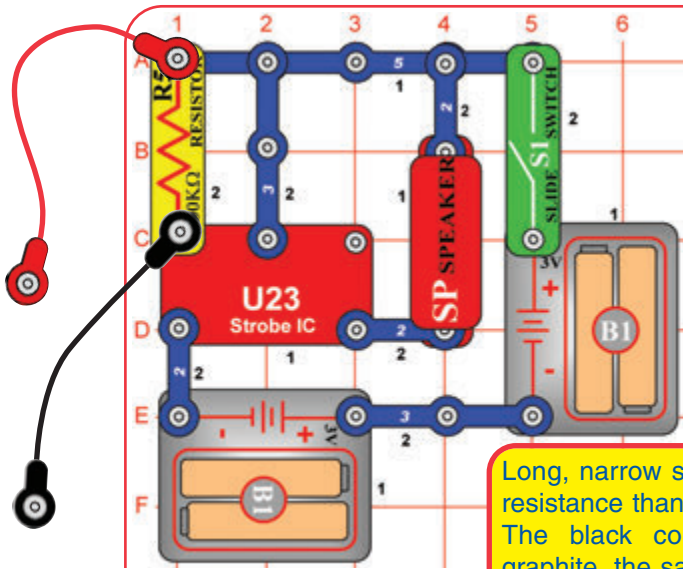

Build the circuit and turn on the switch (S1). Make your parts using either the water puddles method (A), the drawn parts method (B), or the pencil parts method (C). Touch the jumper wires to your parts and read the current.

Long, narrow shapes have more resistance than short, wide ones. The black core of pencils is graphite, the same material used in the resistors in the pivot stand.



Musical Shapes

Method A (easy): Spread some water on the table into puddles of different shapes, perhaps like the ones shown here. Touch the jumper wires to points at the ends of the puddles.



Method B (challenging): Use a SHARP pencil (No. 2 lead is best) and draw shapes, such as the ones here. Draw them on a hard, flat surface. Press hard and fill in several times until you have a thick, even layer of pencil lead. Touch the jumper wires to points at the ends of the drawings. You may get better electrical contact if you wet the metal with a few drops of water. Wash your hands when finished.

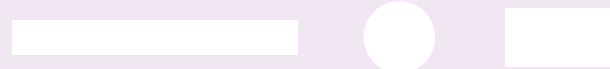

Method C (adult supervision and permission required): Change the setting on the meter to the 50mA scale. Use some double-sided pencils if available, or VERY CAREFULLY break a pencil in half. Touch the jumper wires to the black core of the pencil at both ends.



Project 145 Human & Liquid Sounds

Use the preceding circuit but touch the metal in the jumper wires snaps with your fingers. Wet your fingers for best results. Your fingers will change the sound, because your body resistance is less than the 100kΩ resistor (R5) in the circuit.

Next, place the loose ends of the jumper wires in a cup of water, make sure the metal parts aren't touching each other. The water should change the sound.

Now add salt to the water and stir to dissolve it. The sound should have higher pitch now, since salt water has less resistance than plain water.

Don't drink any water used here.



Project 146 Human & Liquid Light

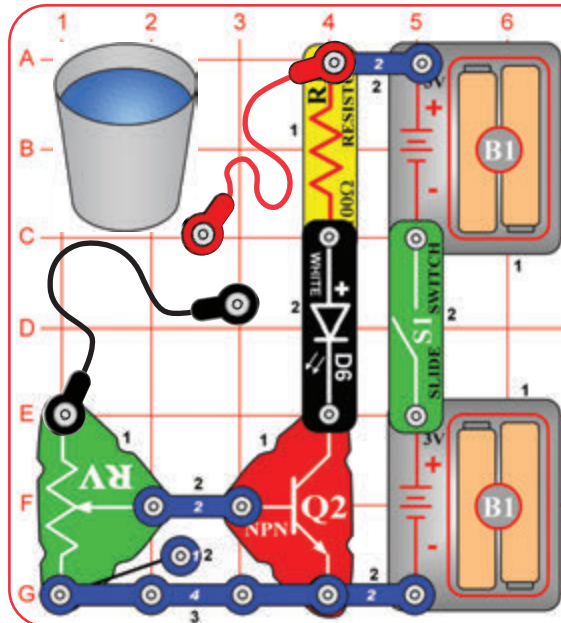

Build the circuit and turn on the switch (S1). Touch the metal in the jumper wire snaps with your fingers. Use the lever on the adjustable resistor (RV) to adjust the sensitivity of the circuit. You may see a difference in the light brightness just by pressing the contacts harder with your fingers.

Next, place the loose ends of the jumper wires in a cup of water, make sure the metal parts aren't touching each other. The water should change the light brightness. Readjust sensitivity using RV.

Now add salt to the water and stir to dissolve it. The light should be brighter, since salt water has less resistance than plain water. Readjust sensitivity using RV.

Don't drink any water used here.



Project 147

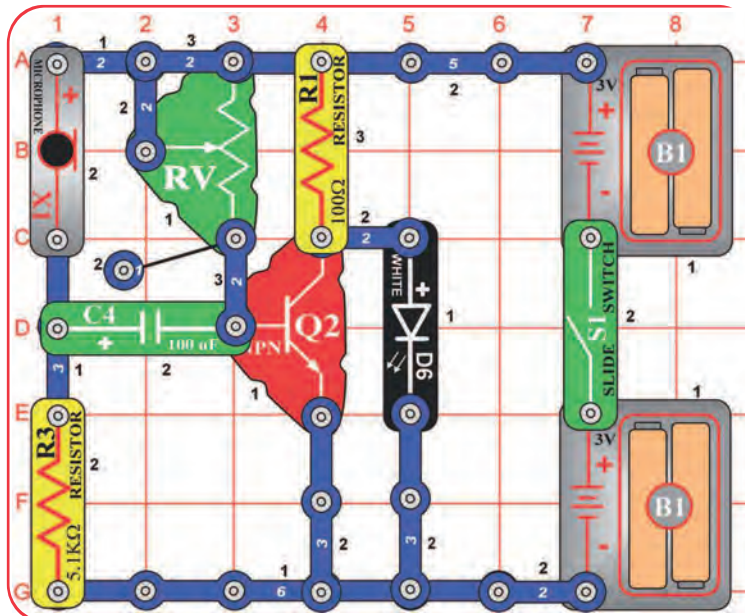

Blow On the Light

The microphone is a resistor that changes in value due to changes in air pressure on its surface.



Build the circuit and turn on the slide switch (S1). Blow on the microphone (X1) to turn on the white LED (D6).
The adjustable resistor (RV) is used here as a fixed resistor, so moving the lever on it will not affect the circuit.



Project 148

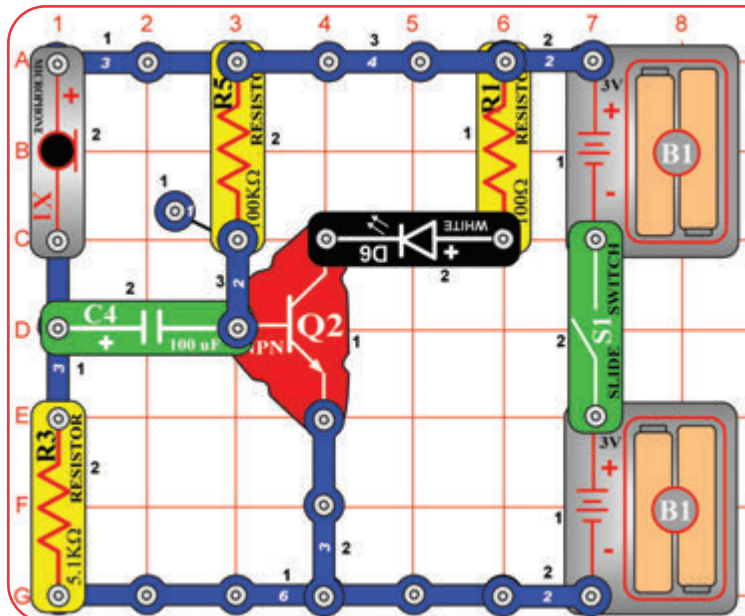

Blow Off the Light

Build the circuit and turn on the slide switch (S1). Wait for the white LED (D6) to come on. Blow into the microphone (X1) to make the white LED turn off for a moment.

Project 149

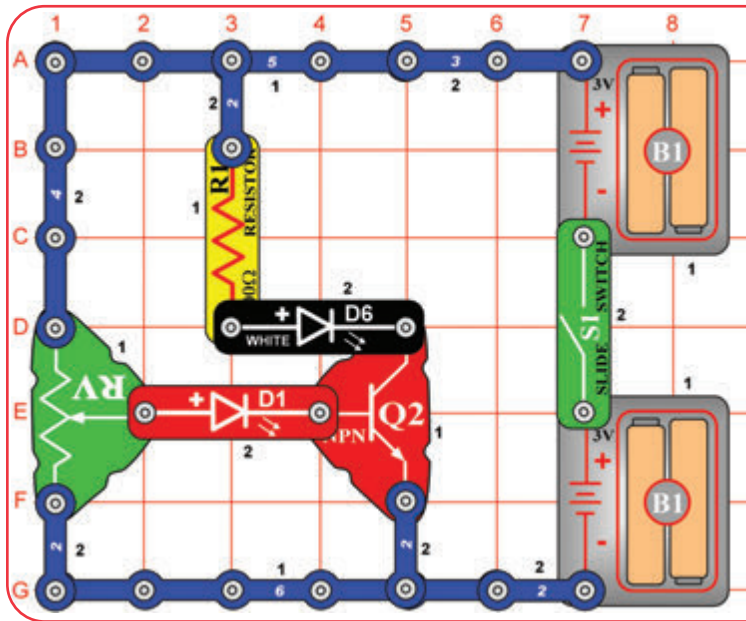

Transistor

Build the circuit and turn on the slide switch (S1). Slowly move the lever on the adjustable resistor (RV) across its range while watching the brightness of the red & white LEDs (D1 & D6).

Transistors, such as the NPN transistor (Q2), can amplify electric currents. In this circuit, the adjustable resistor controls a small current going to the transistor through the red LED. The transistor uses this small current to control a larger current through the white LED. At some RV settings, the control current is too small to light the red LED, but the transistor-amplified is large enough to light the white LED.



Project 150

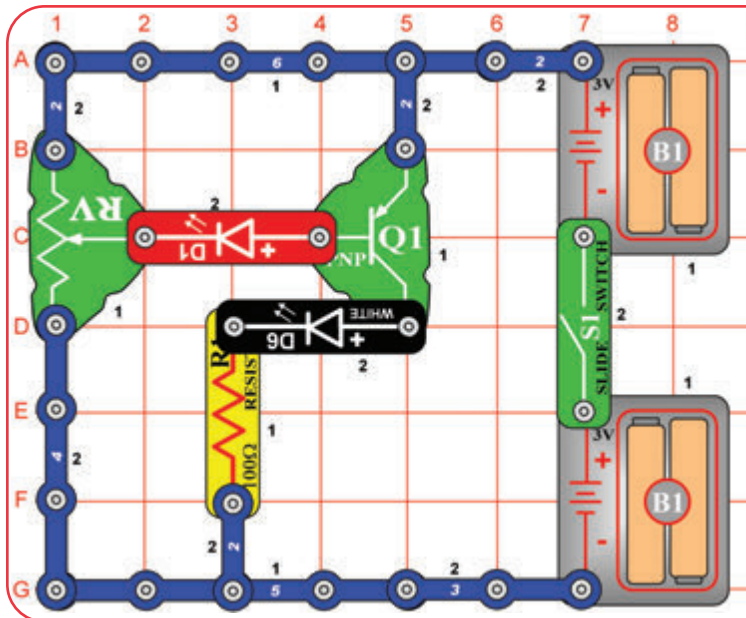

Another Transistor

The PNP transistor (Q1) is just like the NPN transistor (Q2), except that the currents flow in opposite directions.

This circuit is just like the preceding one, except uses a different type of transistor. Build the circuit and turn on the slide switch (S1). Slowly move the lever on the adjustable resistor (RV) across its range while watching the brightness of the red & white LEDs (D1 & D6).



Project 151 Charging & Discharging

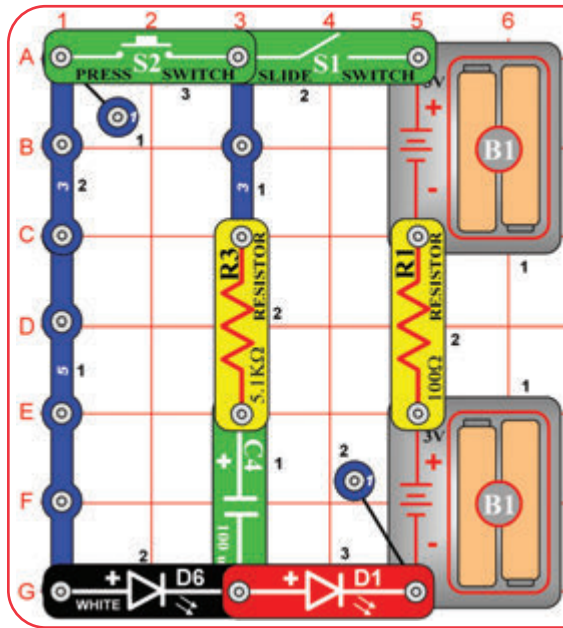

Turn on the slide switch (S1) for a few seconds, then turn it off. The red LED (D1) is dimly lit for a few moments but goes completely dark as the batteries (B1) charge up the 100µF capacitor (C4). The capacitor is storing electrical charge.

Now press the press switch (S2) for a few seconds. The white LED (D6) is initially bright but goes dim as the capacitor discharges itself through it.

The C4 capacitor value (100µF) sets how much charge can be stored in it, and the R3 resistor value (5.1kΩ) sets how quickly that charge can be stored or released.

Now swap the locations of the white & red LEDs, and try the circuit again. Both LEDs have the same electrical current flowing through them, but white LED is much brighter than the red LED because it is a super-bright LED while the red one isn't.

Project 152

Mini Capacitor

Use the preceding circuit but replace the 100µF capacitor (C4) with the 0.1µF capacitor (C2). The circuit works the same, but the LEDs will only light very briefly, because the smaller 0.1µF capacitor stores much less electricity than the larger 100µF capacitor.

Project 153 Adjustable Charging & Discharging

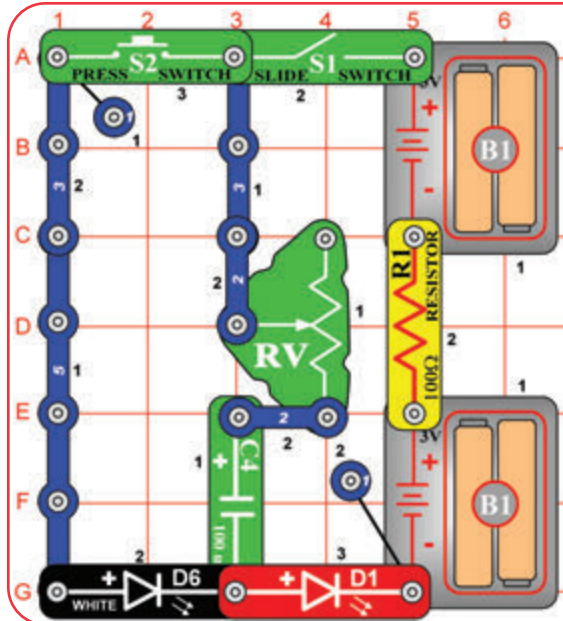

Adjustable Charging & Discharging

Modify the project 152 circuit to be this one, which has the adjustable resistor (RV) instead of the 5.1kΩ resistor (R3). Use the lever on RV to adjust the capacitor charge & discharge rate, setting it towards the red LED (D1) will make the LEDs flash brighter but get dim faster.

Project 154 Mini Battery

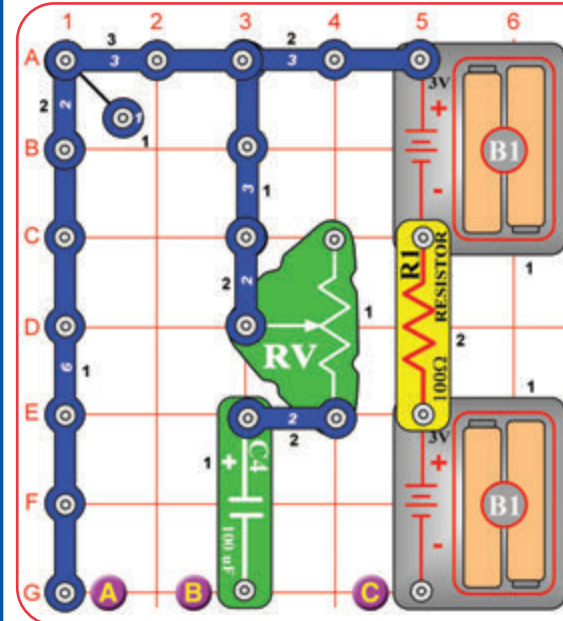

This circuit is similar to the preceding one, but may be easier to understand. Set the lever on the adjustable resistor (RV) towards the 100µF capacitor (C4). Place the white LED (D6) across the points marked B & C; the LED lights as the capacitor charges. Next, place the white LED across points A & B instead; now the LED lights as the capacitor discharges. Move the white LED back to B & C and repeat. Use the lever on RV to vary the charge / discharge rate.

The capacitor is storing energy like a mini battery.

Project 155 Photo Current Amplifier

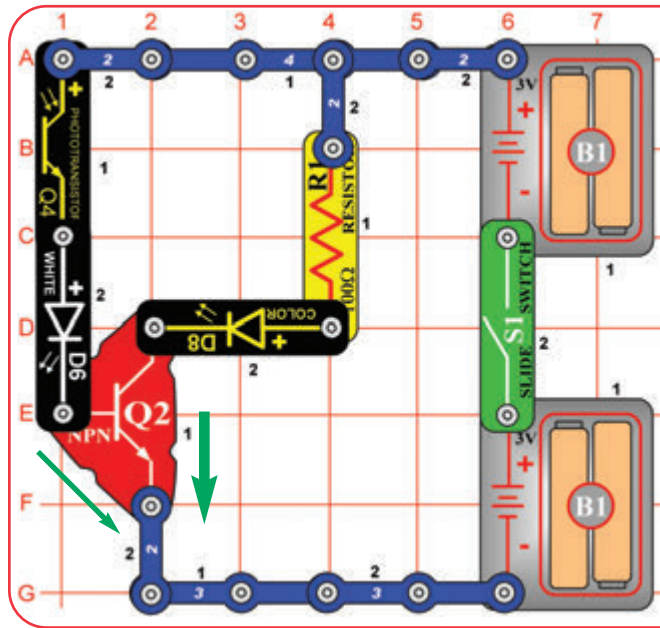

Build the circuit, turn on the switch (S1), and vary the amount of light on the phototransistor (Q4) using your hand. Compare the brightness of the white LED (D6) and color LED (D8).

Swap the locations of the white and color LEDs, and compare the brightness now.

The NPN transistor (Q2) is a current amplifier. When a small current flows into Q2 through the left branch (through Q4), a larger current will flow into Q2 through the right branch (with R1). **Green arrows show the current flow.** So the LED on the right side will be brighter than the LED on the left side. The current in the right branch might be 100 times larger than in the left branch.



Project 156 LEDs & Transistors

Use the preceding circuit but replace either LED (D6 or D8) with the red LED (D1). Compare all three LEDs, in both locations.

LED brightness depends on the materials used, construction quality, and the current through it. The white LED is super-bright, the red LED is low-brightness, and the color LED is between the others.

Project 157

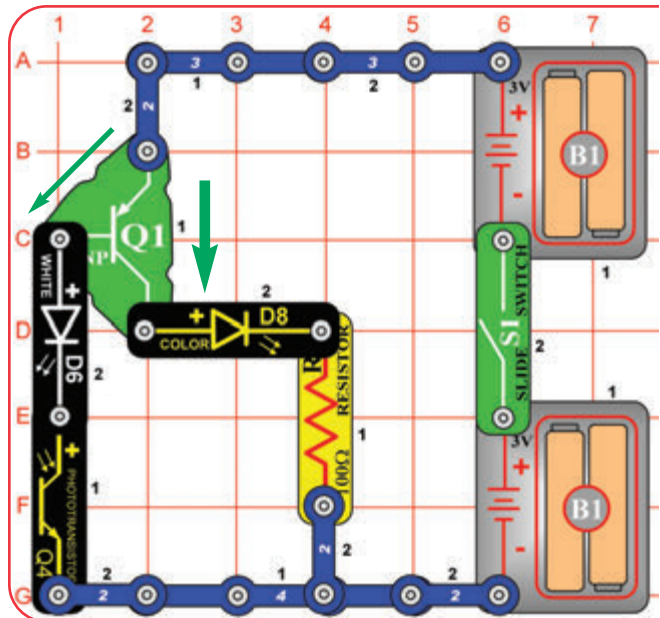

The PNP transistor (Q1) is just like the NPN transistor (Q2), except that the currents flow in opposite directions. **Green arrows show the current flow.**



PNP Amplifier

This circuit is just like the preceding one except it uses a different type of transistor. Build the circuit, turn on the switch (S1), and vary the amount of light on the phototransistor (Q4) using your hand. Compare the brightness of the white LED (D6) and color LED (D8).

Replace either LED (D6 or D8) with the red LED (D1). Compare all three LEDs, in both locations.

Project 158

Photo Control

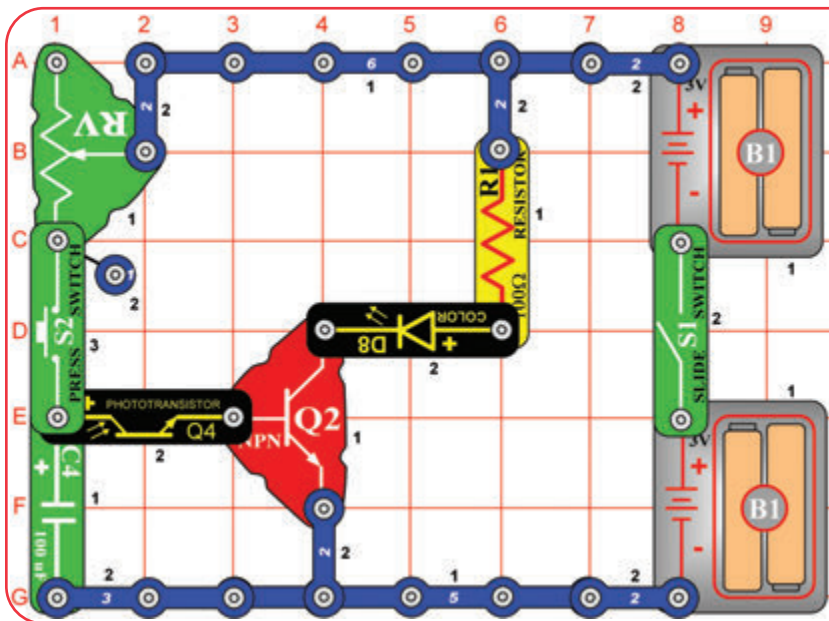

Set the lever on the adjustable resistor (RV) all the way towards the press switch (S2). Turn on the slide switch (S1), and push the press switch. The color LED (D8) will light for a while and then slowly turn off. The brighter the light on the phototransistor (Q4), the longer the color LED stays on.

You can replace the color LED with the red LED (D1) or the white LED (D6).

Project 159

Resistance Director

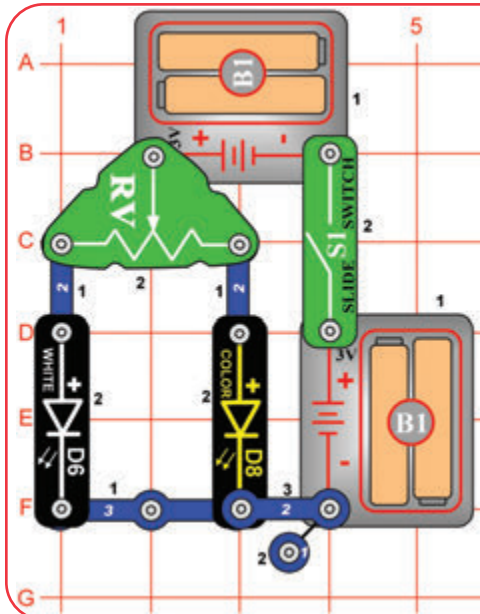

The adjustable resistor can be adjusted from about 200 ohms to about 50,000 ohms.

The white LED is a super-bright LED, so will be brighter than the others at comparable resistance.



Move the lever on the adjustable resistor (RV) across its range and watch the brightness of the white and color LEDs (D6 & D8).

Replace either LED with the red LED (D1) and compare it too.

You can also replace one of the battery holders (B1) with a 3-snap wire, and compare the LED brightnesses at lower voltage.



Project 160

Current Controllers - Series

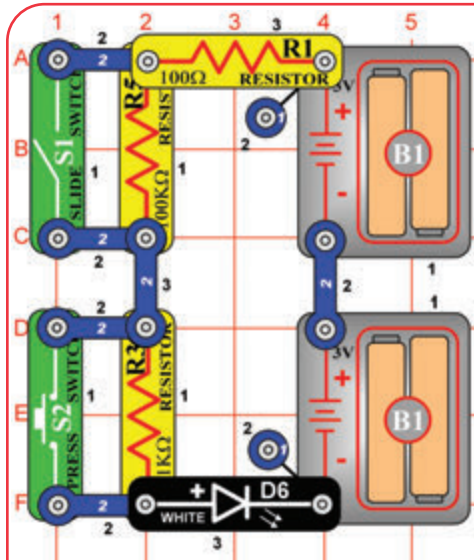

Resistors are used to control the amount of current through a circuit. Increasing the resistance decreases the current.



Turn on either or both switches (S1 & S2) and compare the white LED (D6) brightness. This circuit has the 100Ω resistor (R1), the 5.1kΩ resistor (R3), and the 100kΩ resistor (R5) arranged in series. The switches are used to bypass the larger resistors. The largest resistor controls the brightness in this arrangement.



Project 161

Current Controllers - Parallel

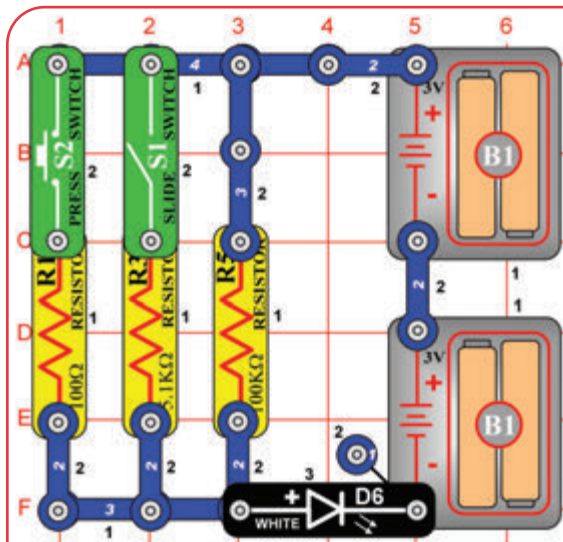

Turn on either or both switches (S1 & S2) and compare the white LED (D6) brightness. This circuit has the 100Ω resistor (R1), the 5.1kΩ resistor (R3), and the 100kΩ resistor (R5) arranged in parallel. The switches are used to disconnect the smaller resistors. The smallest resistor controls the brightness in this arrangement.



Project 162

Blow Sound Changer

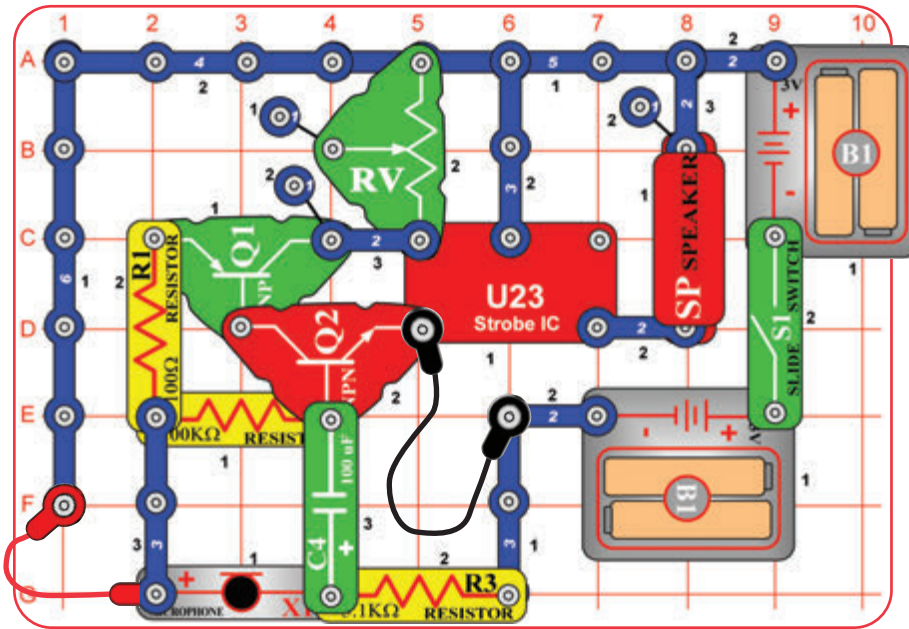

When you turn on the switch (S1), you hear a siren sound. Blow into the microphone (X1) to change the sound. RV is used as a fixed resistor (50kΩ); so moving its control lever will have no effect.



Project 163

Short Light

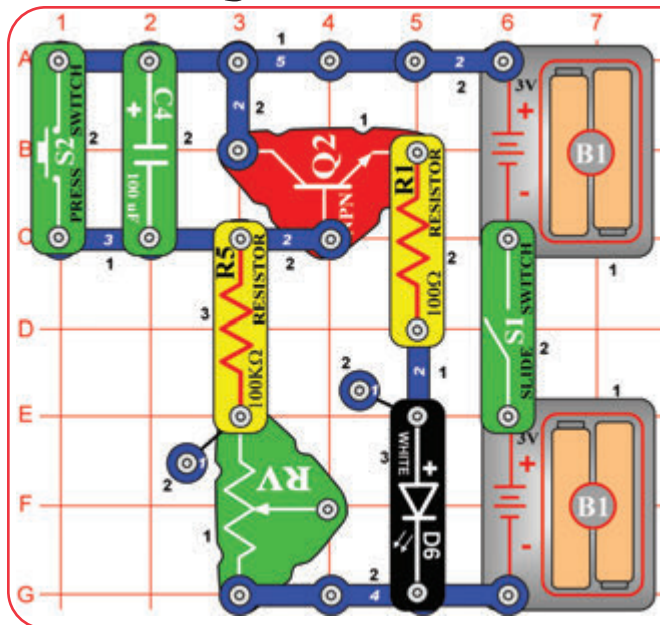

The light is on while the 100µF capacitor (C4) is charging, and shuts off when the capacitor gets fully charged. Pressing S2 discharges the capacitor. The charge-up time is set by the capacitor's value and resistors R5 and RV.



Build the circuit, turn on the slide switch (S1), and push the press switch (S2). The white LED (D6) is on for a while and then shuts off. Turning S1 off and back on will not get the light back on. Push S2 to get the light back on. Replace the white LED with the color LED (D8) to change the light style. RV is used as a fixed resistor (50kΩ); so moving its control lever will have no effect.



Project 164 Shorter Light

Use the preceding circuit but replace the 100kΩ resistor (R5) with the smaller 5.1kΩ resistor (R3). Now the light doesn't stay on as long.



Project 165

Photo Light Control

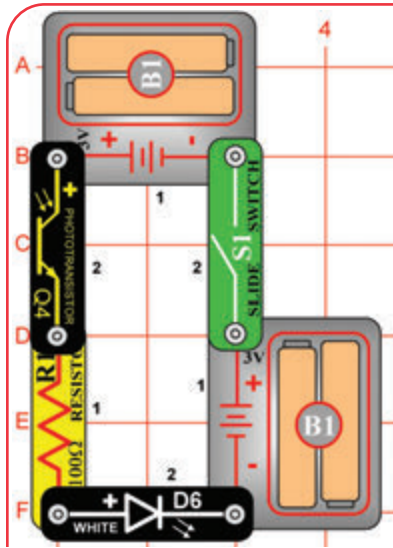

The phototransistor uses light to control electric current. As more light shines on the phototransistor, the current through it increases, making the LED brighter.



Turn on the switch (S1). Control the white LED (D6) brightness by varying the amount of light on the phototransistor (Q4). Try holding the red, green, and blue filters over the phototransistor and see how they affect it.

Replace the white LED with the red LED (D1) or the color LED (D8) and compare them.



Project 166

Air Pressure Light Control

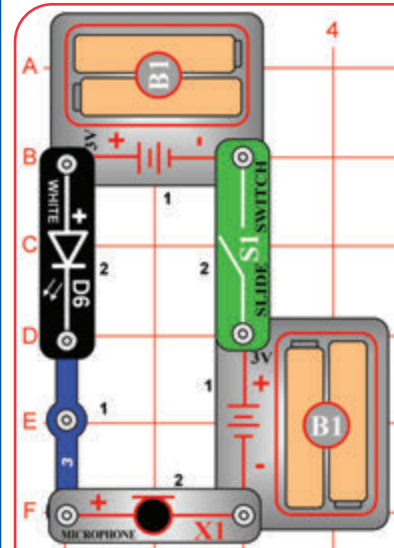

Blow on the microphone (X1). The white LED (D6) will flicker, because the resistance of the microphone changes when you blow on it.

Talking into the microphone also changes its resistance, but you will not be able to notice the difference here.

You can replace the white LED with the red LED (D1) or the color LED (D8), but they will not be very bright.



Project 167

Slow On, Slower Off

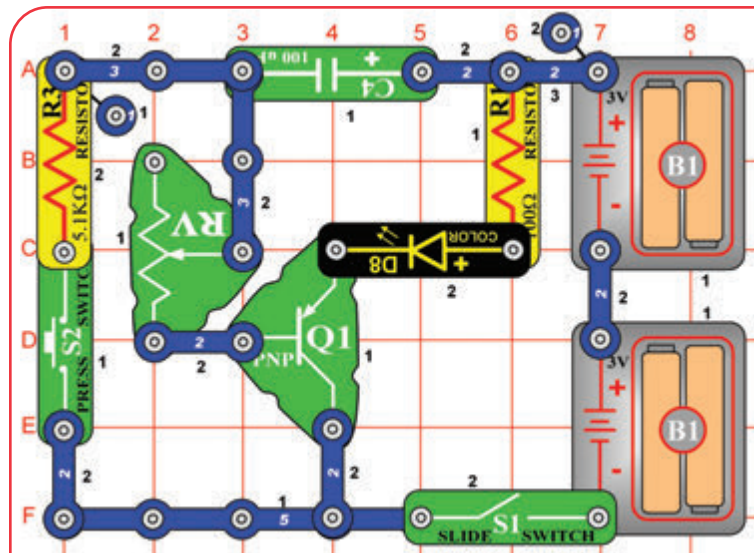

Turn on the slide switch (S1), nothing happens. Now push the press switch (S2) and hold it down. The color LED (D8) takes a few seconds to turn on, then will very slowly get dim. The adjustable resistor (RV) controls the shut-off time.

You can replace the color LED with the red LED (D1) or the white LED (D6).

The 100µF capacitor (C4) controls the color LED through the PNP transistor (Q1). Pressing S2 quickly charges up the capacitor, and releasing S2 allows the capacitor to slowly discharge. Capacitors can store electric charge and release it when needed, so they are often used in timing circuits like this.

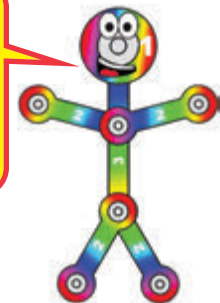



Project 168

Delayed Photo Speed Control

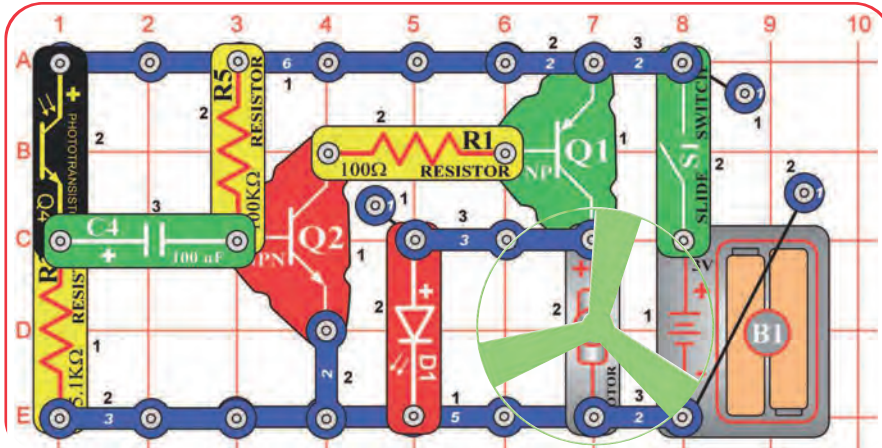

Turn on the switch (S1), the motor (M1) spins. As you move your hand over the phototransistor (Q4), the motor slows. Cover the phototransistor with your hand. The motor slows down and may stop, but will speed up in a few seconds. Also try shining a flashlight into the phototransistor.

WARNING: Moving parts. Do not touch the fan or motor during operation.



Project 169

Delayed Speed Control

Use the preceding circuit, but replace the 100µF capacitor (C4) with the much smaller 0.1µF capacitor (C2). Now varying the light to the phototransistor has a smaller effect on the motor speed.



Project 170

Delayed Speed Control (II)

Use the circuit from project 169, but swap the locations of the phototransistor (Q4) and 5.1kΩ resistor (R3); put "+" on Q4 towards C4. Now increasing the light to the phototransistor slows down the motor, instead of speeding it up.



Project 171

Audio Delayed Speed Control

Use the circuit from project 169, but replace the phototransistor (Q4) with the microphone (X1). Clap, talk loudly, or blow into the microphone to change the motor speed. Replace the 100µF capacitor (C4) with the much smaller 0.1µF capacitor (C2). Now the microphone has a smaller effect on the motor speed.



Project 172

Photo Speed Control

Turn on the switch (S1), and set the adjustable resistor (RV) so the motor (M1) just spins. Slowly cover the phototransistor (Q4) and the motor spins faster. Place more light on the phototransistor and the motor speeds up.

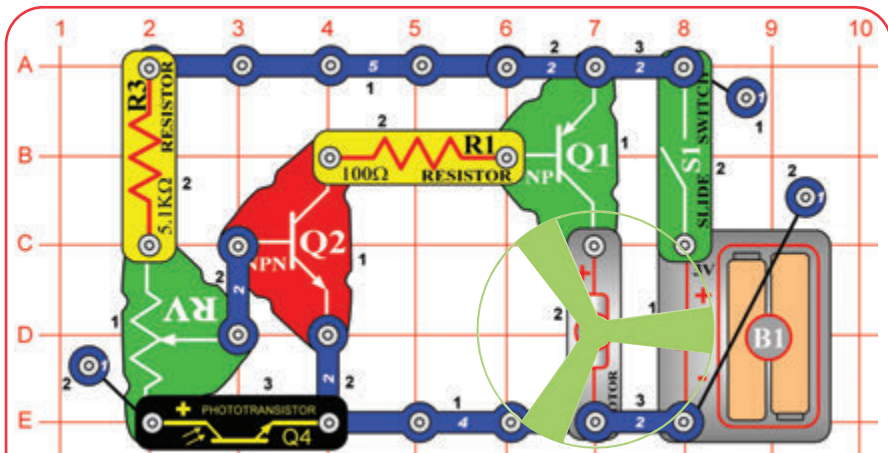

WARNING: Moving parts. Do not touch the fan or motor during operation.



Project 173

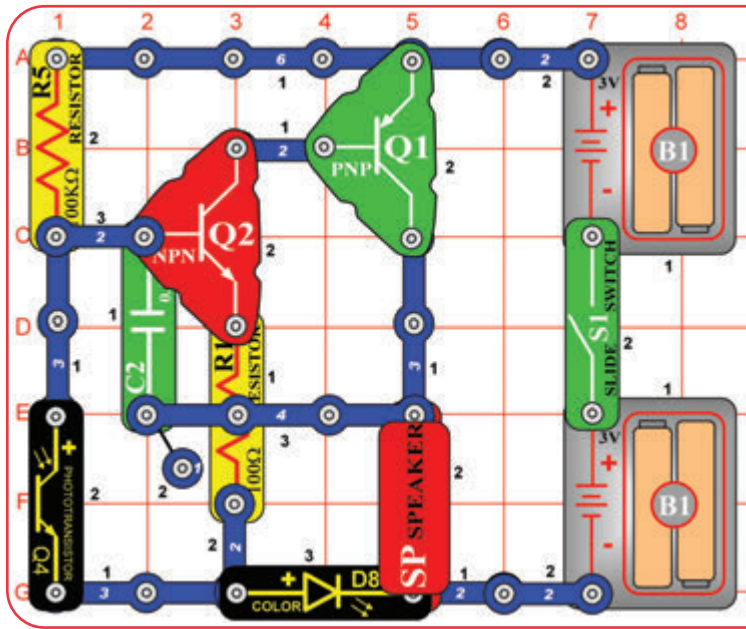

Light Buzz

Turn on the switch (S1). If there is enough light on the phototransistor (Q4), then nothing will happen. Cover the phototransistor with your finger, now the speaker (SP) makes noise and the color LED (D8) flashes. Wave your fingers over the phototransistor to vary the sound.

Replace the color LED with the red or white LEDs (D1 & D6). The light and sound will be a little different.



Project 174

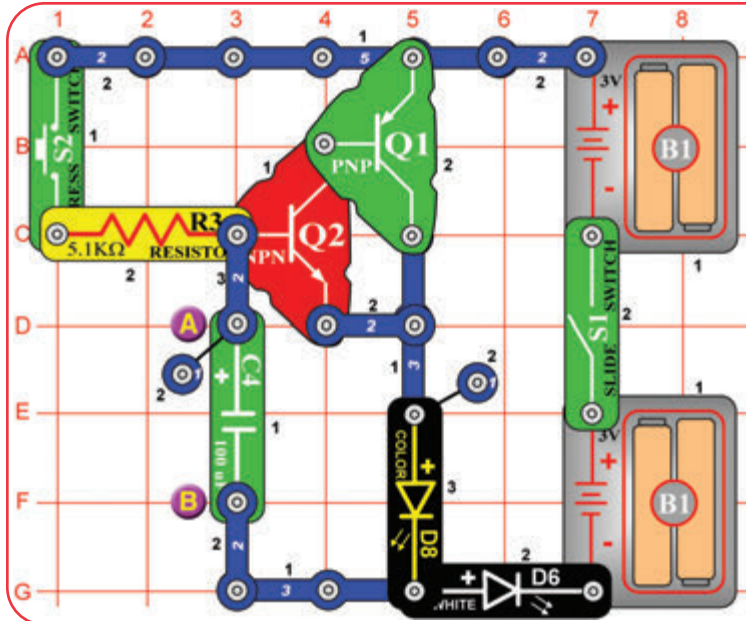

Delay Lights

Turn on the slide switch (S1), and push the press switch (S2). The color and white LEDs (D6 & D8) come on slowly but will stay bright for a long time after you release the press switch. Connect the red jumper wire across points A & B if you get tired of waiting for the LEDs to turn off.

Replace the 5.1kΩ resistor with the 100kΩ resistor. Now you have to push the press switch for much longer to make the LEDs bright.

Project 175 Touch Light

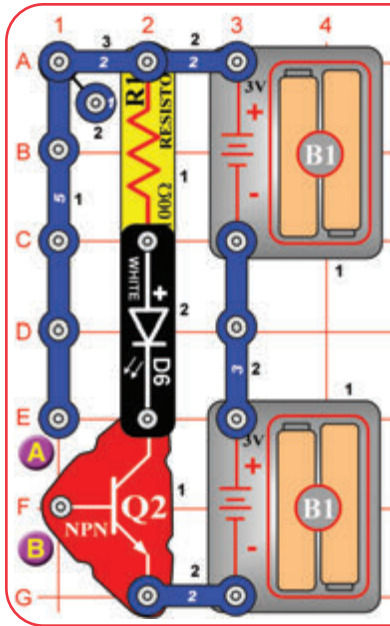

Build the circuit. It doesn't do anything, and may appear to be missing something. It is missing something, and that something is you.

Touch points A & B with your fingers. The white LED (D6) may be lit. If isn't bright, then you are not making a good enough electrical connection with the metal. Try pressing harder on the snaps, or wet your fingers with water or saliva. The LED should be bright now. You can replace the white LED with the red or color LEDs (D1 & D8).

Project 176 Narrow Range Tone

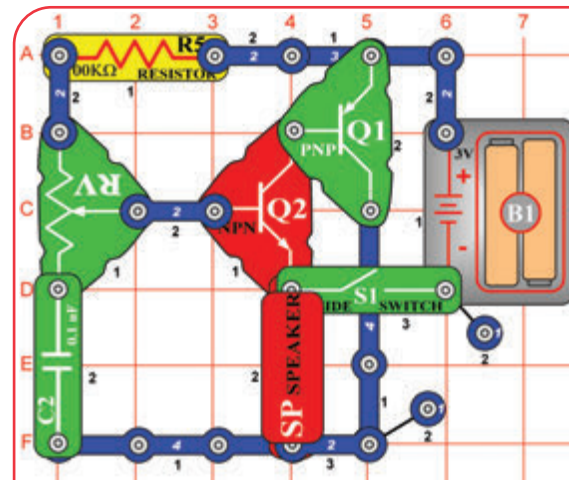

Turn on the switch (S1) and move the lever on the adjustable resistor (RV) around. The circuit makes a tone sound, but only over a small range of settings on RV.

Replace the 100kΩ resistor (R5) with the 5.1kΩ resistor (R3). The tone is a little different now.

Project 177

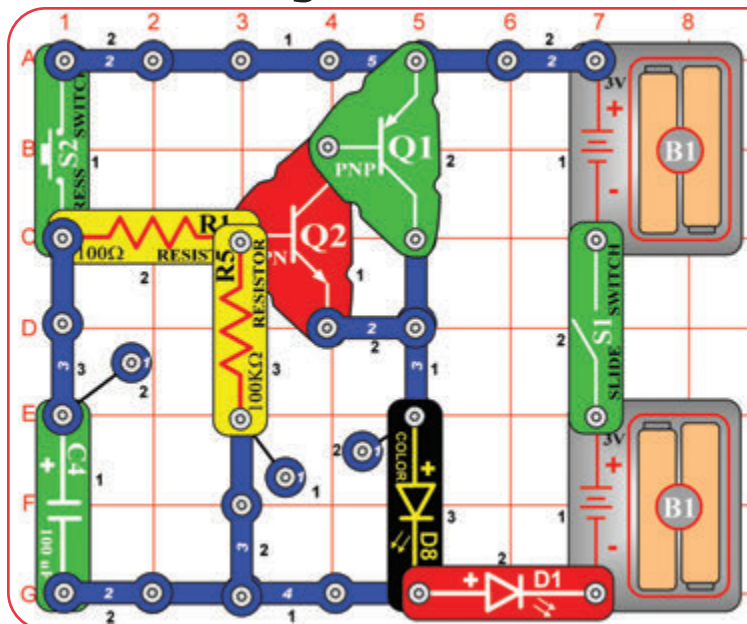

Turn on the slide switch (S1), and push the press switch (S2). The red and color LEDs (D1 & D8) stay on for a few seconds after you release the press switch.

You can change how long the LEDs stay on for by replacing the 100μF capacitor with the 0.1μF capacitor, by replacing the 100kΩ resistor (R5) with the 5.1kΩ resistor (R3), or by removing the 100kΩ resistor.

For more fun, try swapping the locations of the LEDs, or replacing either with the white LED (D6).



Project 178

3D Pictures

Look at the picture here and on the next page; they probably look blurry. Now place the red filter in front of your left eye and the blue filter in front of your right eye, and look at the pictures again. Now the pictures look clearer, and you can see them in three dimensions (3D).



This picture contains separate red & blue images, taken from slightly different viewpoints, combined together. When you view it through the red & blue filters, each eye sees only one image. Your brain combines the two images into the single picture that you “see”, but the differences between the two images make the combined picture seem three-dimensional.

How 3D works:

Most people have two eyes, spaced about 2 inches apart. So each eye sees the world a little differently, and your brain uses the difference in views to calculate distance. For each object in view, the greater the difference between the two scenes, the closer it must be. If you close one eye, you will have a harder time judging distance – try catching a ball with just one eye! (Be sure to use a soft ball if you try playing catch with one eye.)

When you watch a 3D movie in a theater, you wear 3D glasses so that each eye will see a different image. The movie screen actually shows two images, and the glasses filter them so that only one image enters each eye. Most movie theaters use polarized images and glasses with polarized lenses, so that each eye sees a different image.

Another way to make 3D is using red & blue images, then view using glasses with red & blue filters, as you are doing in this project. Unfortunately this method does not give you the color quality that the polarization method has.



3D Pictures

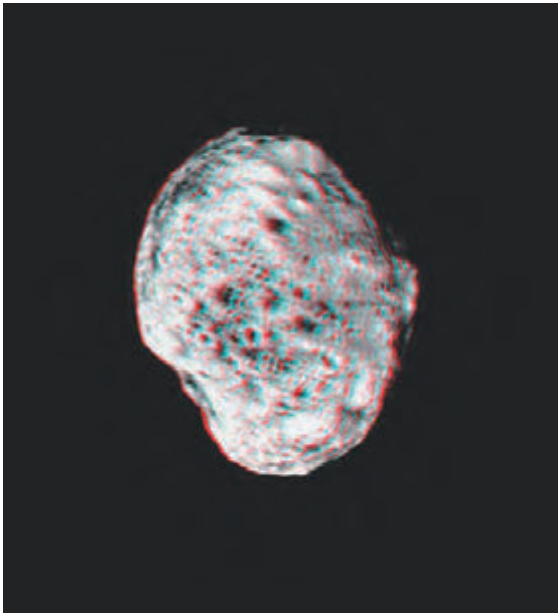

Project 179

Infrared Optical Audio

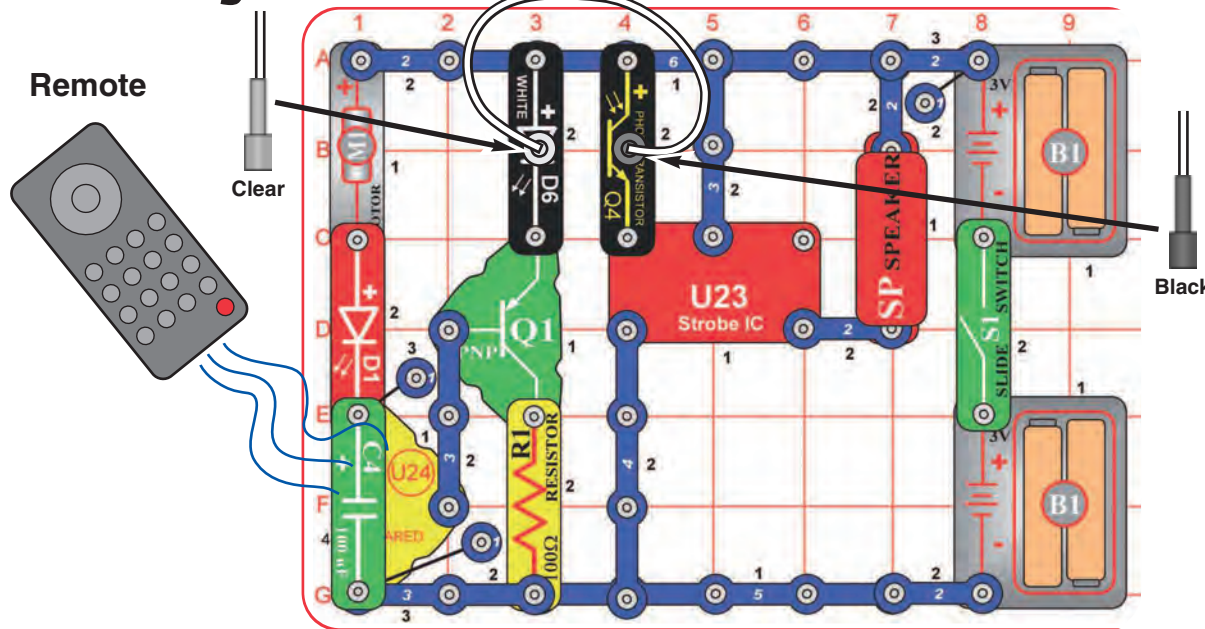

You need an infrared remote control for this project, such as any TV/stereo/DVD remote control in your home.

Build the circuit as shown. Place the clear cable holder on the color LED (D8) and the black cable holder on the phototransistor (Q4), then place the fiber optic cable into the holders as far as it will go. For best performance the fiber optic cable should stand straight up in the holders, without bending them.

Turn on the switch (S1). Point your remote control toward the infrared module (U24) and press any button to activate the white LED (D6). Light is transmitted from the white LED, through the fiber optic cable, to control the strobe IC (U23) and speaker (SP).

The motor (M1) is used as a 3-snap here, and will not spin.

Project 180

Test the Color Organ

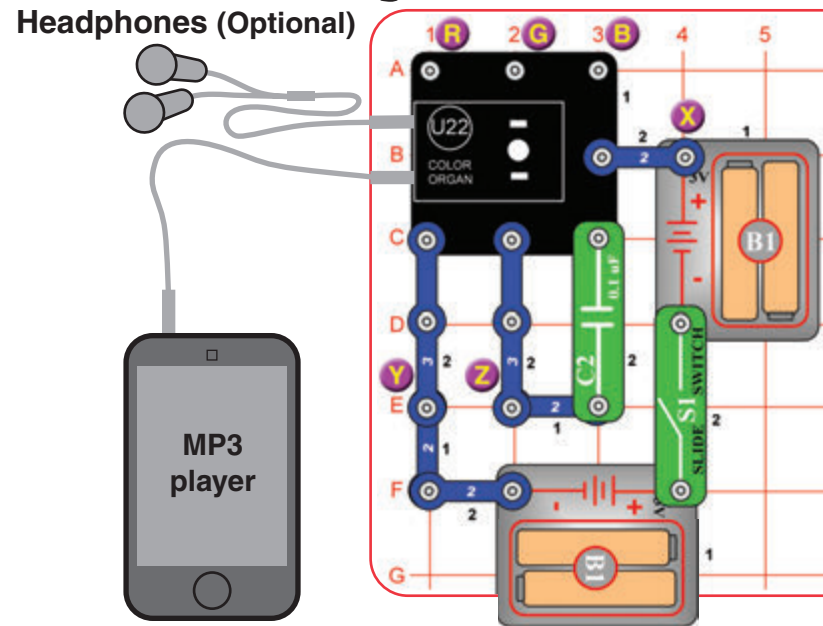

This project tests the features of the color organ (U22), and will be referenced by the Advanced Troubleshooting section on page 15.

- Build the circuit, and turn on the switch (S1). The light on top of the color organ should be changing colors.
- Remove the 0.1µF capacitor (C2), add a 2-snap across the points marked Y & Z, and reset the circuit by turning it off and on using the switch. Connect the red jumper wire between the point marked "X", and points marked "R", "G", or "B" in the drawing. Touching R should make the light red, G should make it green, and B should make it blue.
- Remove the 2-snap that was added across points Y & Z. Connect a music device (not included) and headphones (optional, and not included) to the color organ as shown, and start music on it. Set the volume control on your music device so that the light on the color organ is changing (the light will not change if your volume is set too high or too low).

BOFFIN

More Boffin building sets are available at:
www.boffin.cz

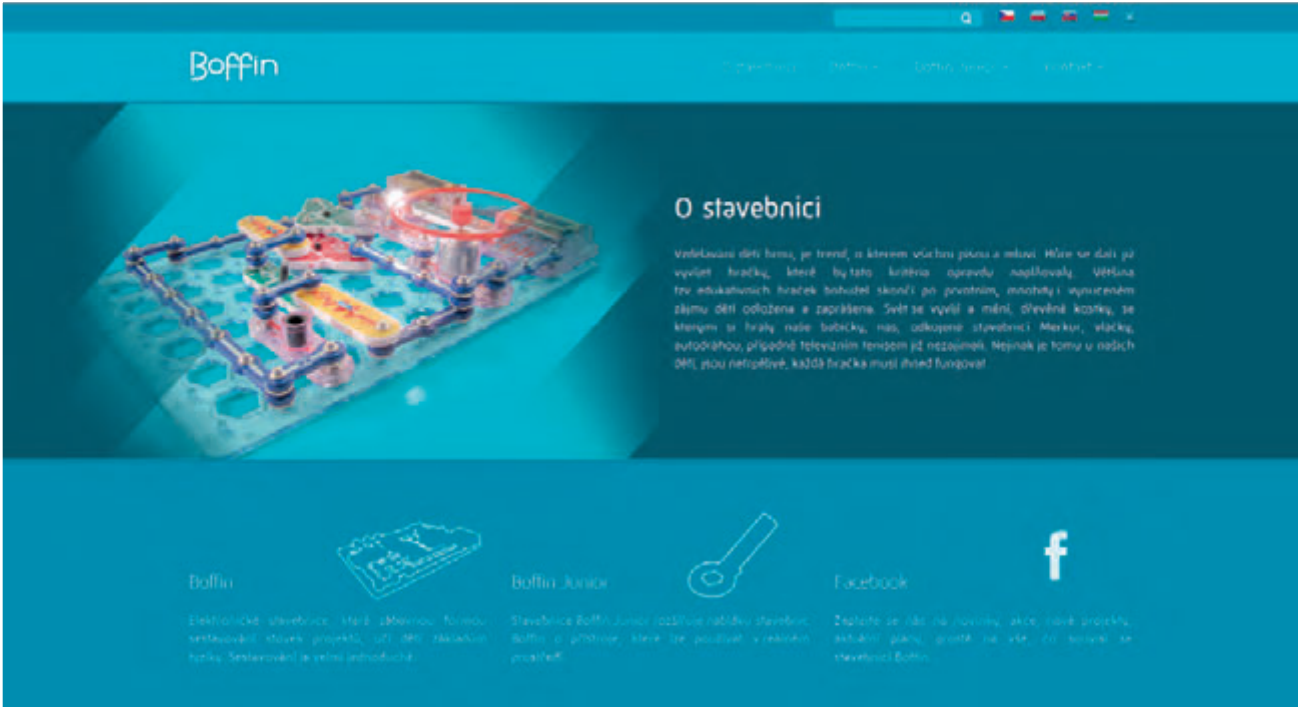

The screenshot shows the Boffin website with a teal header. The main content area features a large image of a Boffin building set on the left and a text block on the right. Below this are three smaller sections with icons and text: a circuit board icon for 'Boffin', a key icon for 'Boffin klíče', and a Facebook 'f' icon for 'Facebook'.

Boffin

O stavebnici

Většinou děti hrají, je trend, v kterém učí hrájí pokusů a měření. Měří se dají při výhled hračky, které by tato kritéria opravdu naplňovaly. Většina tzv. edukativních hraček bývá jen skříňka pro prázdnou, mnohdy i vystrašením plánu dětí odložena a zaprášena. Svět se vyvíjí a máni dřevěné kostky, se kterými si hrály naše babičky, nos, odkopané stavebnici Merkur, vložky, autodráhou, případně televizním tenisem již nezapomeli. Nejen je tomu u našich dětí, jsou nezapomenutelné, každá hračka musí ihned fungovat!

Boffin

Elektronické stavebnice, které zlepšíte, mohou vytvořit stavební projekty, při nichž získáte fyziku. Stavebnice je velmi interaktivní.

Boffin klíče

Stavebnice Boffin Junior (2018) jsou nádherné stavebnice Boffin a přitom, které se používají v reálném světě!

Facebook

Způsob je rád na novinky, akce, nové projekty, stavební projekty, projekty, které se staly, při kterých se stavebnice Boffin.

ConQuest entertainment a. s.
Kolbenonva 961, 198 00 Praha 9,
www.boffin.cz, www.toy.cz
info@boffin.cz



WWW.TOY.CZ